

WORKPRO[®]

NOT JUST PROFESSIONAL



2023

**HAND TOOLS
CATALOG**

GREATSTAR GROUP



40.000
COMPANY STAFF



10.7 B
2022 REVENUE



3
LISTED COMPANIES

GreatStar was founded in 1993, is a global manufacturing group company with diversified businesses. The group owns the world's second largest hand tool company, as well as the largest tire manufacturer and the largest forklift enterprise in China.

FIVE CORE INDUSTRIES

<p>Hangzhou GreatStar Industrial</p> <p>Stock code: 002444</p>	<p>No.2 largest hand tool manufacturer in the world.</p>	
<p>Hangcha Group</p> <p>Stock code: 603298</p>	<p>The largest forklift truck manufacturer in China.</p>	
<p>ZC Rubber</p>	<p>No. 1 Tire manufacturer in China.</p>	
<p>Guozi Robot</p>	<p>The leading mobile robot supplier in the world.</p>	
<p>Xinchai</p> <p>Stock code: 301032</p>	<p>No.1 industrial diesel engine manufacturer in China.</p>	

GREATSTAR INDUSTRIAL



5
R&D BASES

12,000
COMPANY STAFF

\$2.0 B
2022 REVENUE

GreatStar Industrial is principally engaged in R&D, manufacturing, and sales of hand tools, power tools, Laser Measuring Tools, vacuum cleaner and storage tools. GreatStar Industrial is not only the second largest hand tool manufacturer in the world, but also the world's largest manufacturer of laser measuring tools and steel storage products.

GLOBAL MANUFACTURING

20 MANUFACTURING BASES AROUND THE WORLD

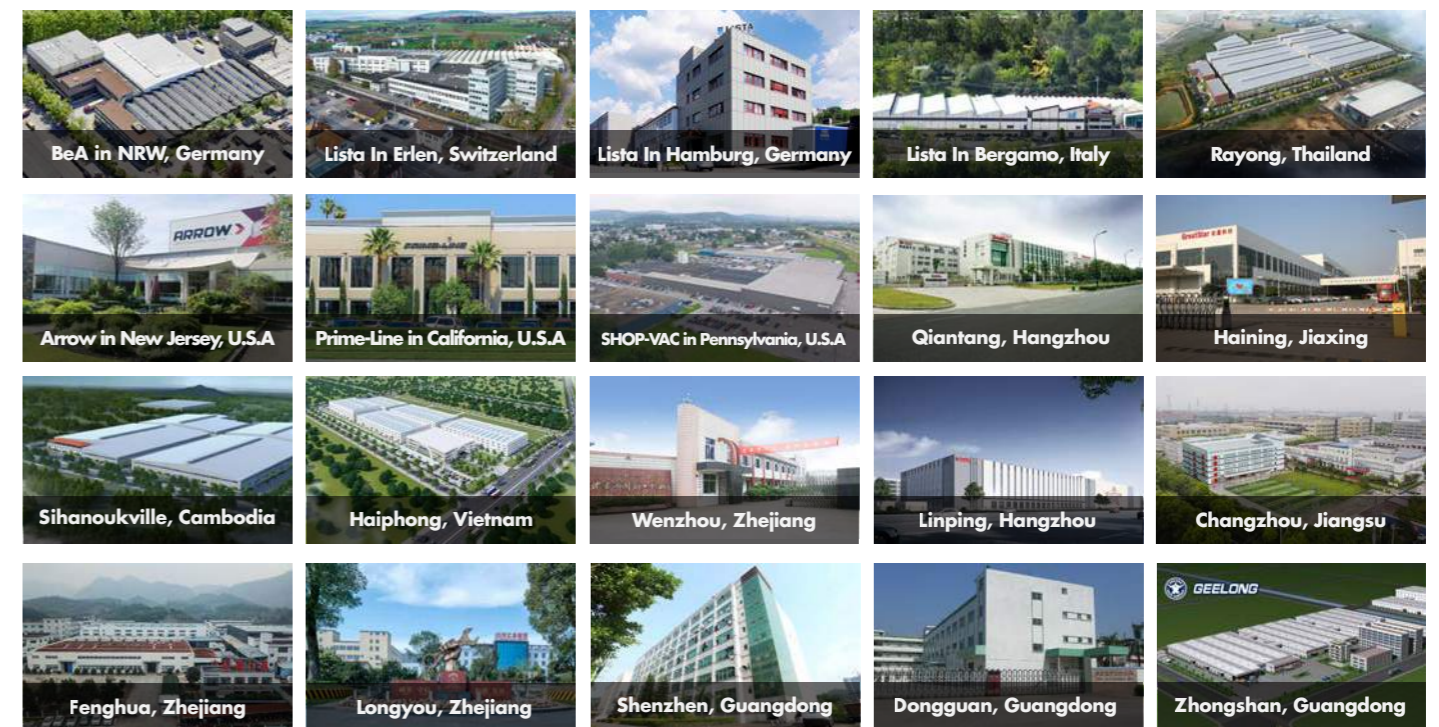

HAND TOOLS



POWER TOOLS



PPE



PTA



GARDEN TOOLS



AIR TOOLS



EQUIPMENTS



ILLUMINATION

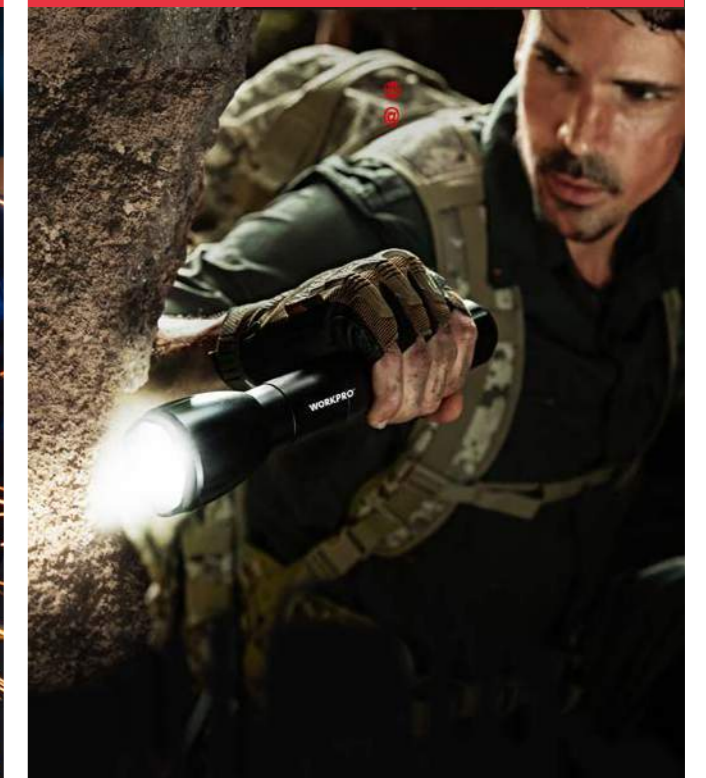

NOT JUST PROFESSIONAL

BUT ALSO

GREAT PRICE, GREAT QUALITY, GREAT SERVICE.

OUR USERS

INDUSTRIAL USERS, PROJECT BUILDERS, AND
DIYERSECT BUILDERS, AND DIYERS

OUR SLOGAN

NOT JUST PROFESSIONAL

OUR VISION

BECOME GLOBAL SELECTED BRANDS STATION &
GLOBAL LEADING ONE-STOP TOOLS SUPPLIER

OUR VALUES

CUSTOMER FOCUS, SINCERITY, INNOVATION,
TOGETHER, EXCELLENCE

OUR PROMISE

GREAT PRICE, GREAT QUALITY, GREAT SERVICE

ONE BRAND, TWO RANGES.

WORKPRO tools are divided into two ranges
- WORKPRO BLUE & WORKPRO RED.

WORKPRO BLUE

blue range is fit for for
Pros.



WORKPRO RED

red range is tailored to
DIYers.



DISTRIBUTOR SUPPORT

WORKPRO launches the "MI-FAST" program to fully support the development and growth of our distributors from six areas.

M.I. - Prior to Marketing and Innovation

F.A.S.T. - Devotion to Finance, Award, Service and Training



Finance



Marketing

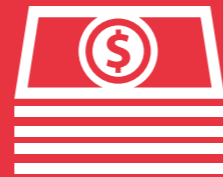

Award



Service



Innovation



Training

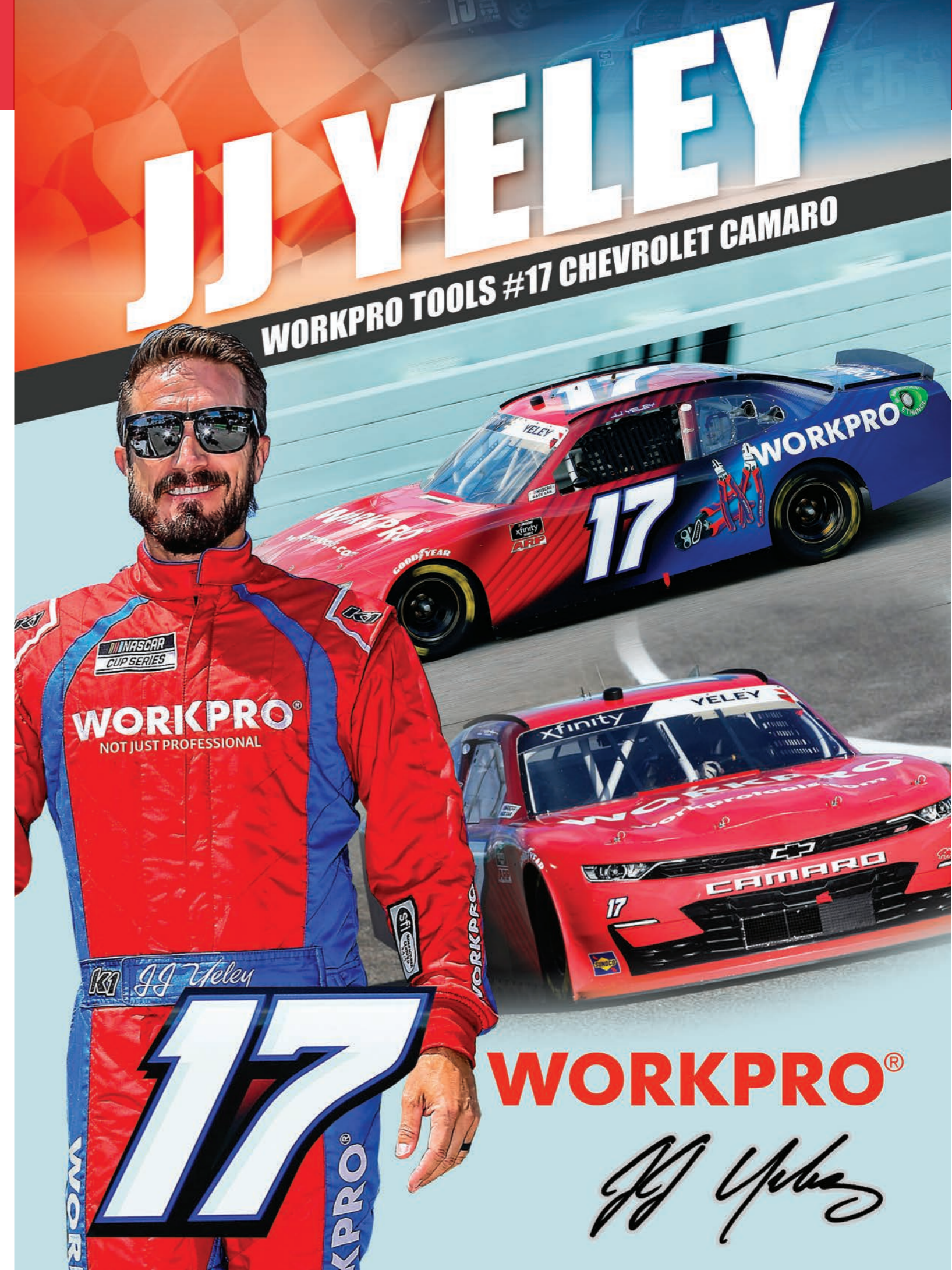



MORE PROMOTIONAL GIFTS

MORE SURPRISES MORE GIFTS MORE BENEFITS



CAP

T-SHIRT

WORK APRON



UMBRELLA

FEATHER FLAG

HAND BAG



DISPLAY RACK

DISPLAY CAR

WORKPRO®
ONE-STOP TOOLS & MACHINES SUPPLIER



CONTENTS

HOLDING TOOLS

PLIERS, CLAMP



001-016

MECHANICS TOOLS

WRENCH, RATCHET HANDLE, SOCKETS



017-038

FASTENING TOOLS

SCREWDRIVER, ALLEN WRENCH



039-064

STRIKING TOOLS

HAMMER, AXE, UTILITY BAR, CHISEL



065-074

CUTTING TOOLS

KNIFE, SCISSORS, SAW



075-098

FINISHING TOOLS

FILE, BRUSH, BLOCK PLANE



099-106

MEASURING TOOLS

TAPE MEASURE, SPIRIT LEVEL



107-118

ELECTRICAL TOOLS

WIRE STRIPPER, CRIMPING PLIERS



119-124

INSULATED TOOLS

VDE TOOLS, VDE TOOL SET



125-134

AUTOMOTIVE TOOLS

GEAR PULLER, LIFTING GEAR, WRENCH



135-142

PLUMBING TOOLS

PIPE CUTTER, FLARING TOOL



143-148

MASONRY & PAINTING TOOLS



149-164

OUTDOOR TOOLS

MULTIFUNCTIONAL TOOL



165-178

MANUAL GARDEN TOOLS

HAND CULTIVATOR, WEEDER, TROWEL



179-182

PERSONAL PROTECTIVE EQUIPMENT

HELMET, WORK GLOVES, SAFETY SUIT



183-190

STORAGE

SOFT STORAGE, PLASTIC STORAGE, STEEL STORAGE, WORK FACILITATION



191-202

TOOL SETS



203-240

HARDWARE & OTHERS



241-242

POINT REDEMPTION



243-246

WARRANTY GUIDE



247-248



**HOLDING
TOOLS**

**PLIERS
CLAMP**

MULTI-PURPOSE COMBINATION PLIERS

30% LABOR SAVING

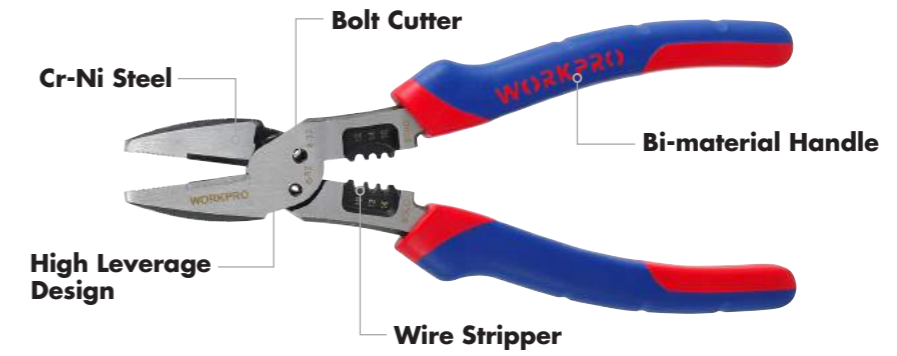

Model #	Description
WP231085	200mm(8")

SUPER LABOR-SAVING PLIERS

50% LABOR SAVING



Also available:



Model #	Description
WP231088	200mm(8") long nose pliers
WP231089	200mm(8") combination pliers
WP231090	180mm(7") diagonal pliers



2-IN-1 FLIP PLIERS

GREATER EFFICIENCY

- CR-V
- Bi-material handle anti-slip and ergonomic
- Heat-treated for longer life
- Spring-loaded jaws for easy use

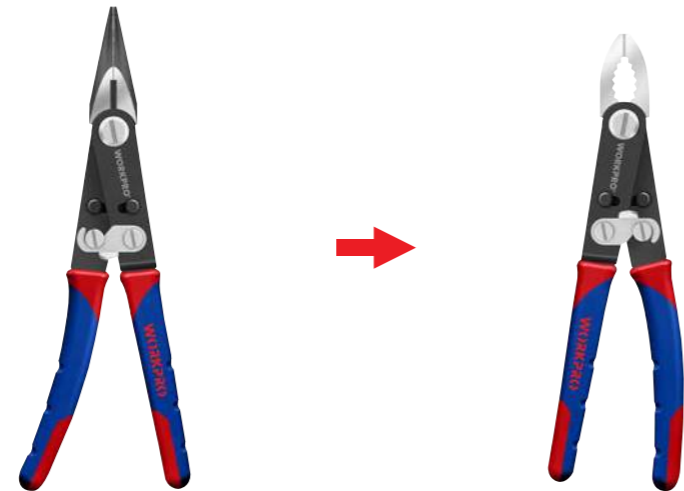
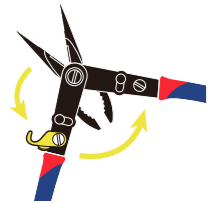

Model #	Description
WP231084	200mm(8")

QUICK-ADJUST WATER PUMP PLIERS

QUICK ADJUST SUPER SELECTED



Model #	Description
WP231086	200mm(8")
WP231087	250mm(10")
WP201005	2PC

CR-V COMBINATION PLIERS

ECCENTRIC AND LABOR-SAVING



Model #	Description
WP231024	160mm(6")
WP231025	180mm(7")
WP231026	200mm(8")

CR-V DIAGONAL PLIERS

- CR-V forged steel
- Eccentric and labor-saving structure
- Hardened cutting edge
- 30% wider handle



Model #	Description
WP231022	160mm(6")
WP231066	180mm(7")

Model #	Description
WP231023	180mm(7")

CR-V LONG NOSE PLIERS

- CR-V forged steel
- Eccentric and labor-saving structure
- Hardened cutting edge
- With cable pulling function
- 30% wider handle



Model #	Description
WP231020	160mm(6")
WP231021	200mm(8")

CR-V END CUTTING PLIERS

- Hardened cutting edge strong shearing force
- 30% wider handle



Model #	Description
WP231027	180mm(7")

CR-V WATER PUMP PLIERS

- V-jaw multi-fit shapes
- CR-V forged
- Tri-color grip
- 30% wider handle



Model #	Description
WP231028	250mm(10")
WP231029	300mm(12")

COMBINATION PLIERS

- Drop forged steel
- Ni-Fe coating for durability
- Bi-material handle
- 30% wider handle



Model #	Description
WP231016	160mm(6")
WP231017	180mm(7")
WP231018	200mm(8")

DIAGONAL PLIERS

- Drop forged steel
- Ni-Fe coating for durability
- Bi-material handle
- 30% wider handle



Model #	Description
WP231014	160mm(6")

BENT NOSE PLIERS

- Drop forged steel
- Ni-Fe coating for durability
- Bi-material handle
- 30% wider handle



Model #	Description
WP231015	180mm(7")

LONG NOSE PLIERS

- Drop forged steel
- Ni-Fe coating for durability
- Bi-material handle
- 30% wider handle



Model #	Description
WP231012	160mm(6")
WP231013	200mm(8")

BENT NOSE PLIERS

- Drop forged steel
- Bi-material handle
- 30% wider handle



Model #	Description
WP231042	160mm(6")
WP231043	200mm(8")

END CUTTING PLIERS

- Drop forged steel
- Ni-Fe coating for durability
- Bi-material handle
- 30% wider handle



Model #	Description
WP231019	180mm(7")

STRIPPER PLIERS

- Drop forged steel
- Bi-material handle
- 30% wider handle



Model #	Description
WP231041	160mm(6")

SLIP JOINT PLIERS

- Drop forged steel
- Bi-material handle
- 30% wider handle



Model #	Description
WP231044	160mm(6")
WP231045	200mm(8")

3PC PLIERS SET (6"+6"+8")

- Drop forged steel
- Bi-material comfort grip handle



Model #	Description
WP201007	8" combination pliers, 6" long nose pliers, 6" diagonal pliers

DIAGONAL PLIERS

- Drop forged steel
- Easy-to-clean handle



Model #	Description
WP231006	160mm(6")
WP231007	190mm(7-1/2")

SLIP JOINT PLIERS

- Drop forged steel
- Easy-to-clean handle



Model #	Description
WP231008	160mm(6")
WP231009	200mm(8")

3PC PLIERS SET (6"+6"+6")

- Drop forged steel
- Bi-material comfort grip handle



Model #	Description
WP201008	6" long nose pliers, 6" diagonal pliers, 6" combination pliers

COMBINATION PLIERS

- Drop forged steel
- Easy-to-clean handle



Model #	Description
WP231001	160mm(6")
WP231002	180mm(7")
WP231003	200mm(8")

LONG NOSE PLIERS

- Drop forged steel
- Easy-to-clean handle



Model #	Description
WP231004	160mm(6")
WP231005	200mm(8")

WATER PUMP PLIERS

- Drop forged steel
- Easy-to-clean handle



Model #	Description
WP231010	250mm(10")
WP231117	300mm(12")

FENCE PLIERS

- Drop forged steel
- Easy-to-clean handle



Model #	Description
WP231011	250mm(10")

MINI LONG NOSE PLIERS

- Drop forged steel
- Easy-to-clean handle



Model #	Description
WP231034	120mm

MINI DIAGONAL PLIERS

- Drop forged steel
- Easy-to-clean handle



Model #	Description
WP231035	105mm

MINI COMBINATION PLIERS

- Drop forged steel
- Easy-to-clean handle



Model #	Description
WP231036	106mm

MINI END CUTTING PLIERS

- Drop forged steel
- Easy-to-clean handle



Model #	Description
WP231037	104mm

MINI NEEDLE NOSE PLIERS

- Drop forged steel
- Easy-to-clean handle



Model #	Description
WP231038	145mm

MINI BENT NOSE PLIERS

- Drop forged steel
- Easy-to-clean handle



Model #	Description
WP231039	120mm

CR-V CURVED JAW LOCKING PLIERS

CR-V Jaw
For maximum durability



Model #	Description
WP231072	130mm(5")
WP231073	180mm(7")
WP231074	250mm(10")

CR-V LONG NOSE STRAIGHT JAW LOCKING PLIERS

- Tri-color handle slip resistant
- CR-V jaw for maximum durability
- Adjustable knob
- Quick release



Model #	Description
WP231075	165mm(6-1/2")
WP231076	230mm(9")

3PC CR-V LOCKING PLIERS SET

- Tri-color handle slip resistant
- CR-V jaw for maximum durability
- Adjustable knob
- Quick release



Model #	Description
WP201003	1pc 250mm(10") curved jaw locking pliers, 1pc 180mm(7") curved jaw locking pliers, 1pc 165mm(6-1/2") long nose straight jaw locking pliers

CR-V LONG NOSE LOCKING PLIERS

- CR-V jaw for maximum durability
- Adjustable knob
- Quick release



Model #	Description
WP231050	115mm(4-1/2")
WP231051	165mm(6-1/2")
WP231052	230mm(9")

CR-V LOCKING PLIERS

- CR-V jaw for maximum durability
- Adjustable knob
- Quick release



Model #	Description
WP231053	180mm(7")
WP231054	250mm(10")
WP231055	300mm(12")

CURVED JAW LOCKING PLIERS

- CR-V steel curved jaw
- Adjustable knob
- Quick release



Model #	Description
WP231057	130mm(5")
WP231058	180mm(7")
WP231059	250mm(10")
WP231060	300mm(12")

WELDING LOCKING PLIERS

- Carbon steel jaw
- Adjustable knob
- Quick release



Model #	Description
WP231061	230mm(9")

CHAIN CLAMP LOCKING PLIERS

- Adjustable knob
- Quick release



Model #	Description
WP231062	480mm(19")

CR-V C-CLAMP LOCKING PLIERS

- CR-V jaw for maximum durability
- Adjustable knob
- Quick release



Model #	Description
WP231063	160mm(6")
WP231064	280mm(11")
WP231030	450mm(18")

CR-V C-CLAMP LOCKING PLIERS

- Swivel pad
- CR-V jaw for maximum durability
- Adjustable knob
- Quick release



Model #	Description
WP231031	160mm(6")
WP231067	280mm(11")
WP231068	450mm(18")

SHEET LOCKING PLIERS

- Max. locking surface
- Adjustable knob
- Quick release



Model #	Description
WP231069	Size: 200mm(8"); Opening: 54mm(2-1/8"); Throat depth 39mm(1-1/2")
WP231070	Size: 250mm(10"); Opening: 70mm(2-3/4"); Throat depth 44mm(1-3/4")

CURVED JAW LOCKING PLIERS

- Drop forged steel
- Adjustable knob
- Quick release



Model #	Description
WP231071	250mm(10")

LONG NOSE STRAIGHT JAW LOCKING PLIERS

- Drop forged steel
- Adjustable knob
- Quick release



Model #	Description
WP231040	230mm(9")

4PC LOCKING PLIERS

- Drop forged steel
- Quick release
- Adjustable knob



Model #	Description
WP201001	1pc 130mm(5") curved jaw locking pliers, 1pc 165mm(6.5") long nose jaw locking pliers, 1pc 180mm(7") curved jaw locking pliers, 1pc 250mm(10") curved jaw locking pliers

5PC CR-V LOCKING PLIERS SET

- CR-V steel
- Quick release
- Adjustable knob



Model #	Description
WP201002	1pc 130mm(5") curved jaw locking pliers, 1pc 180mm(7") curved jaw locking pliers, 1pc 250mm(10") curved jaw locking pliers, 1pc 165mm(6-1/2") long nose locking pliers, 1pc 230mm(9") long nose locking pliers

CARPENTER'S PINCER

- Drop forged steel
- Double dipped grip



Model #	Description
WP231048	200mm(8")

TOWER PINCER

- Drop forged steel
- Double dipped grip



Model #	Description
WP231049	225mm(9")

STRAIGHT EXTERNAL CIRCLIP PLIERS

- CR-V
- Easy-to-clean handle



Model #	Description
WP231080	180mm(7")

BENT EXTERNAL CIRCLIP PLIERS

- CR-V
- Easy-to-clean handle



Model #	Description
WP231081	180mm(7")

STRAIGHT INTERNAL CIRCLIP PLIERS

- CR-V
- Easy-to-cle



Model #	Description
WP231082	180mm(7")

BENT INTERNAL CIRCLIP PLIERS

- CR-V
- Easy-to-clean handle



Model #	Description
WP231083	180mm(7")

4-IN-1 CIRCLIP PLIERS SET

- 65Mn steel
- 4 heads meet different working conditions

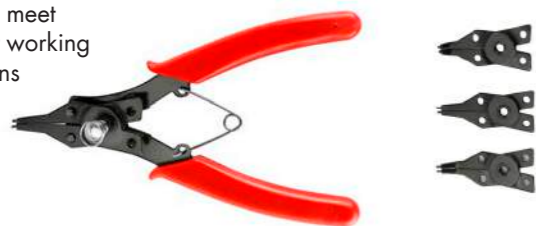

Model #	Description
WP201004	155mm(6")

PUNCH PLIERS

- 360° Revolving
- 2 Efficient lever action for labor-saving
- Comfort grip



Model #	Description
WP231077	6 punch size: 2.0,2.5,3.0,3.5,4.0,4.5mm

BENCH VISE

- Jaws hardened carbon steel
- Cast iron construction
- Fixed base

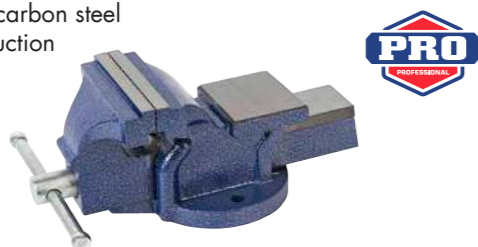

Model #	Description
WP233001	Size:100mm(4"); Jaw width:100mm; Jaw opening: 75mm
WP233002	Size:125mm(5"); Jaw width:125mm; Jaw opening 100mm
WP233003	Size:150mm(6"); Jaw width:150mm; Jaw opening 125mm
WP233004	Size:200mm(8"); Jaw width:200mm; Jaw opening:160mm

DRILL PRESS VISE

- Cast iron base
- Thickened screw smooth rotation



Model #	Description
WP233009	Size:100mm(4")

EYELET PLIERS

- Chrome plated, anti-rust
- Easy-to-clean handle



Model #	Description
WP231079	140mm

HIGH-LEVERAGE PUNCH PLIERS

- 360° Revolving
- 2 Efficient lever action for labor-saving
- Comfort grip
- Safe locking



Model #	Description
WP231078	Punching hole: 3 circulars (aperture diameter 3.5, 4.0, 4.5mm), 2 U-shaped, 1 oval (elliptical hole: 6.1x4mm; Small flat hole: 6.6x3.1mm, big flat hole:7.5x3.6mm)

BENCH VISE WITH SWIVEL BASE

360° SWIVEL BASE

- Jaws hardened carbon steel
- Cast iron construction
- 360° swivel base



Model #	Description
WP233005	Size:100mm(4"); Jaw width:100mm; Jaw opening: 75mm
WP233006	Size:125mm(5"); Jaw width:125mm; Jaw opening 100mm
WP233007	Size:150mm(6"); Jaw width:150mm; Jaw opening 125mm
WP233008	Size:200mm(8"); Jaw width:200mm; Jaw opening:160mm



HEAVY DUTY QUICK RELEASE BAR CLAMP

300LBS

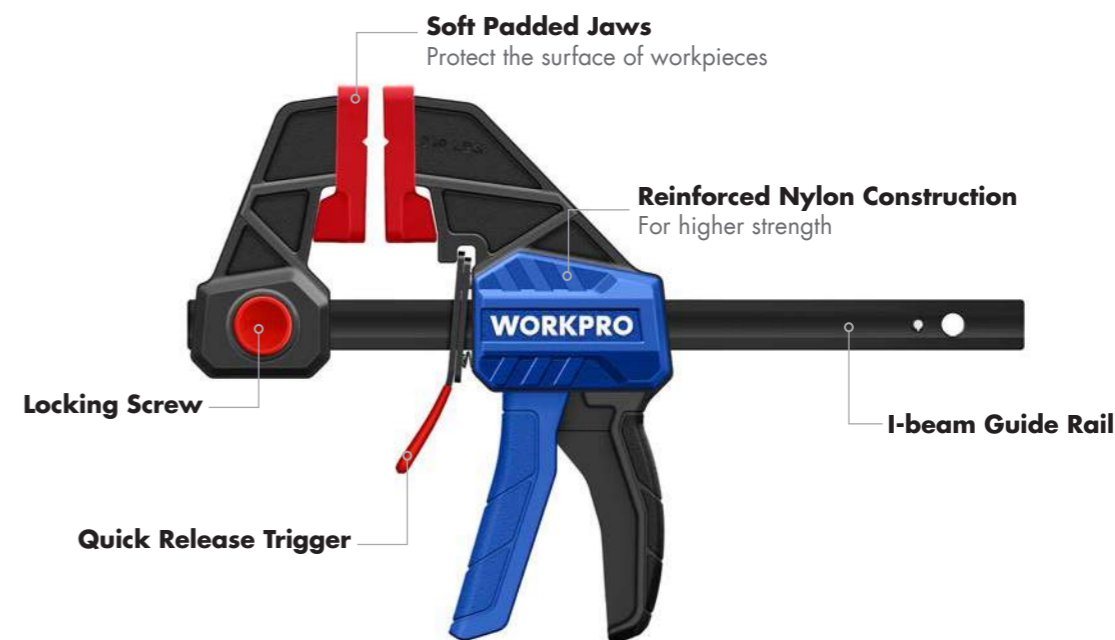

Model #	Description
WP232039	Length: 150mm(6"); Throat Depth: 79mm
WP232040	Length: 300mm(12"); Throat Depth: 79mm
WP232041	Length: 450mm(18"); Throat Depth: 79mm
WP232042	Length: 600mm(24"); Throat Depth: 79mm

LIGHTWEIGHT QUICK RELEASE BAR CLAMP

150LBS

- Quickly converts from a clamp to a spreader
- Soft padded jaws to protect workpiece
- Reinforced nylon construction for strengths



Model #	Description
WP232035	Length: 150mm(6"); Throat Depth: 60mm
WP232036	Length: 300mm(12"); Throat Depth: 60mm

Model #	Description
WP232037	Length: 450mm(18"); Throat Depth: 60mm
WP232038	Length: 600mm(24"); Throat Depth: 60mm

MINI QUICK RELEASE BAR CLAMP

50LBS

- Soft padded jaws to protect workpiece
- Reinforced nylon construction for strengths



Model #	Description
WP232034	1PC; Length: 100mm(4"); Throat Depth: 40mm
WP201016	2PC; Length: 100mm(4"); Throat Depth: 40mm

BAR CLAMP

QUICK-RELEASE AND HEAVY DUTY



BAR CLAMP

- Removable jaw pad
- Wooden handle

Soft Padded Jaws
Protect the surface of workpieces

Quick Adjustment Design

Tri-color Ergonomic Handle

Thickened Serrated Steel Bars



Model #	Description
WP232030	150mm(6")
WP232031	300mm(12")
WP232032	450mm(18")
WP232033	600mm(24")

Model #	Description
WP232025	50X150mm
WP232026	50X200mm
WP232027	80X300mm
WP232028	120X400mm
WP232029	120X600mm

RATCHETING SPRING CLAMP

STRONG RATCHET ACTION



Model #	Description
WP232013	Opening size: 38mm(1-1/2")
WP232014	Opening size: 50mm(2")
WP232015	Opening size: 100mm(4")

SPRING CLAMP

- Reinforced nylon
- Ergonomic handle for comfortable use

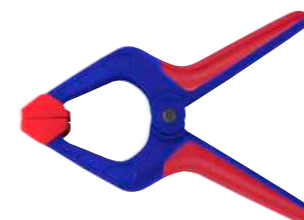

NYLON SPRING CLAMP

- Reinforced nylon construction
- Soft durable pads
- Ergonomic handle



Model #	Description
WP232009	Opening size: 19mm(3/4")
WP232010	Opening size: 25mm(1")
WP232011	Opening size: 50mm(2")
WP232012	Opening size: 75mm(3")

Model #	Description
WP232001	Opening size: 19mm(3/4")
WP232002	Opening size: 25mm(1")
WP232003	Opening size: 50mm(2")
WP232004	Opening size: 75mm(3")

STEEL SPRING CLAMP

- Pvc coating tips
- Nickel-plated steel



Model #	Description
WP232005	Opening size: 19mm(3/4")
WP232006	Opening size: 25mm(1")

Model #	Description
WP232007	Opening size: 50mm(2")
WP232008	Opening size: 75mm(3")

G-CLAMP

- Malleable steel frame
- Swivel pad
- Chrome plated finish screw



Model #	Description
WP232016	25mm(1")
WP232017	50mm(2")
WP232018	75mm(3")
WP232019	100mm(4")
WP232020	150mm(6")
WP232021	200mm (8")

QUICK RELEASE G-CLAMP

- Roll-formed screw threads
- Quick-release mechanism



Model #	Description
WP232022	75mm(3")
WP232023	100mm(4")
WP232024	150mm(6")

90° CORNER CLAMP

- Aluminum
- Reinforced electroplated screw



Model #	Description
WP232043	Clamping width: 75mm(3")

BAND CLAMP

- Removable clamping block suitable for different shapes
- High-strength nylon strap sturdy and durable



Model #	Description
WP232044	294x110x36mm

WELDING MAGNET CLAMPS

MAGNETIC 4-ANGLE LOCATOR

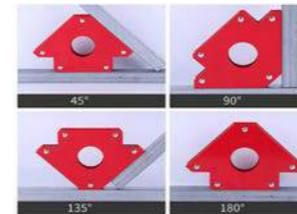

Model #	Description
WP232045	75mm(3"); 25LB
WP232046	100mm(4"); 50LB
WP232047	125mm(5"); 75LB

WELDING MAGNET CLAMPS

- Carbon steel
- Super strong magnet



Model #	Description
WP232048	Small; 25LB
WP232049	Medium; 50LB
WP232050	Large; 75LB



MECHANICS TOOLS

WRENCH
RATCHET HANDLE
SOCKETS AND ACCESSORIES
MECHANICS TOOL SET

2-IN-1 ADJUSTABLE WRENCH & WATER PUMP PLIERS



Model #	Description
WP272014	200mm(8")

UNIVERSAL ADJUSTABLE WRENCH

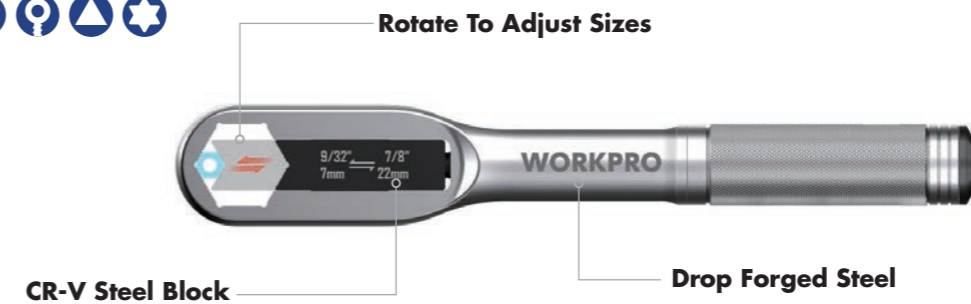

Model #	Description
WP272015	Jaw opening: 7-22mm(9/32"-7/8")

UNIVERSAL WRENCH (METRIC & SAE)



Model #	Description
WP272016	Jaw opening: 5-15mm(3/16"-19/32"), 15-27mm(19/32"-1-1/16")

Model #	Description
WP272017	Jaw opening: 5-11mm(3/16"-7/16"), 11-16mm(7/16"-5/8")

ADJUSTABLE CONSTRUCTION SPUD WRENCH

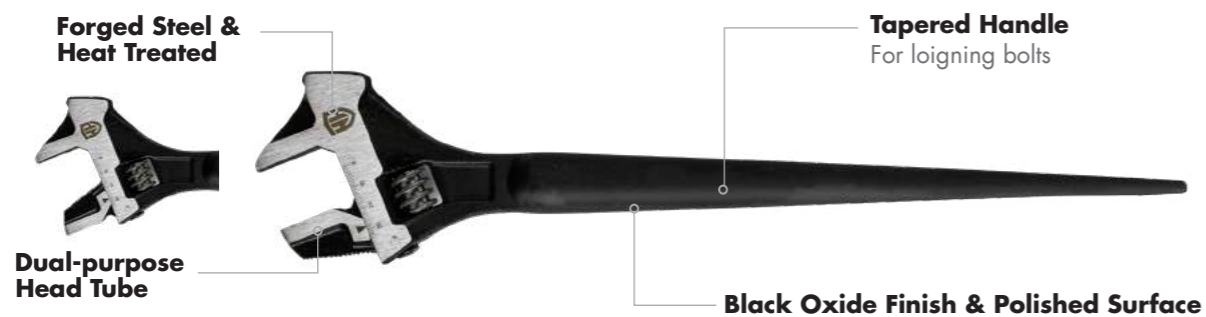

Model #	Description
WP272019	Size: 300mm(12"); Opening size: 34mm

8-IN-1 SOCKET WRENCH

- Forged steel
- Double-headed 360°movable adjustment
- Suitable for 12-point, six-pointed star, square, hexagon and 12-sided screws



Model #	Description
WP272018	8, 10, 11, 13, 14, 16, 17, 19mm; 5/16", 3/8", 7/16", 1/2", 9/ 16", 5/8", 11/16", 3/4"

MULTIFUNCTION WRENCH SET

MULTI PURPOSE

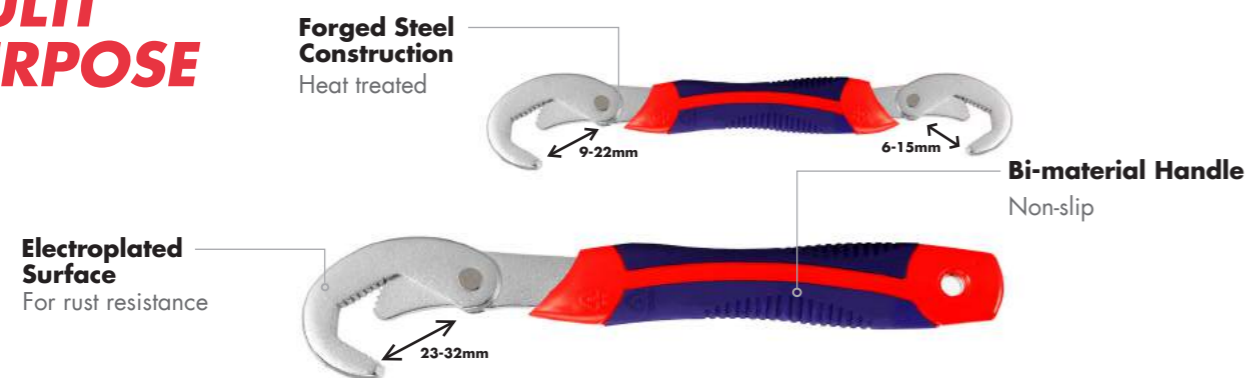

Model #	Description
WP202516	6-32mm

ADJUSTABLE WRENCH

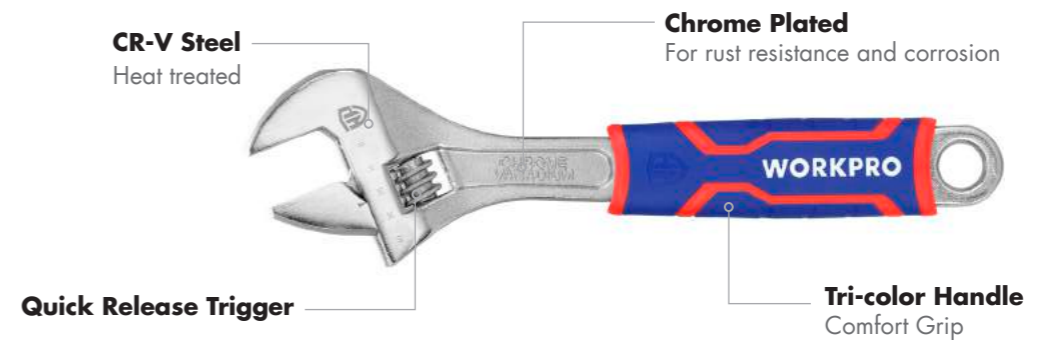

Model #	Description
WP272010	Size: 150mm(6"); Max. jaw capacity: 24mm
WP272011	Size: 200mm(8"); Max. jaw capacity: 30mm

Model #	Description
WP272012	Size: 250mm(10"); Max. jaw capacity: 35mm
WP272013	Size: 300mm(12"); Max. jaw capacity: 40mm

ADJUSTABLE WRENCH SET

- 3PC
- CR-Vsteel construction for strength
- Chrome plated for rust resistance and corrosion
- Dual-material comfort grip handle



Model #	Description
WP202515	150mm, 200mm, 250mm

ADJUSTABLE WRENCH

HEAVY DUTY



Model #	Description
WP272006	Size: 150mm(6"); Max. jaw capacity: 24mm
WP272007	Size: 200mm(8"); Max. jaw capacity: 30mm
WP272008	Size: 250mm(10"); Max. jaw capacity: 35mm
WP272009	Size: 300mm(12"); Max. jaw capacity: 40mm

ADJUSTABLE WRENCH

- Forged steel construction for strength
- Chrome plated for rust resistance and longer life



Model #	Description
WP272001	150mm(6")
WP272002	200mm(8")
WP272003	250mm(10")
WP272004	300mm(12")
WP272005	375mm(15")

COMBINATION WRENCH

- Forged steel
- Chrome plated, mirror polished



Model #	Description
WP273001	6mm
WP273002	7mm
WP273003	8mm
WP273004	9mm
WP273005	10mm
WP273006	11mm
WP273007	12mm
WP273008	13mm
WP273009	14mm
WP273010	15mm
WP273011	16mm
WP273012	17mm
WP273013	18mm
WP273014	19mm
WP273015	20mm
WP273016	21mm
WP273017	22mm
WP273018	23mm
WP273019	24mm
WP273020	25mm
WP273021	26mm
WP273022	27mm
WP273023	28mm
WP273024	29mm
WP273025	30mm
WP273026	32mm

ADJUSTABLE WRENCH SET

- 3PC
- Forged steel construction for strength
- Chrome plated for rust resistance and longer life



Model #	Description
WP202514	150mm, 200mm, 250mm

COMBINATION WRENCH

- Chrome-vanadium steel
- Sand blasting and chrome plated



Model #	Description
WP273027	6mm
WP273028	7mm
WP273029	8mm
WP273030	9mm
WP273031	10mm
WP273032	11mm
WP273033	12mm
WP273034	13mm
WP273035	14mm
WP273036	15mm
WP273037	16mm
WP273038	17mm
WP273039	18mm
WP273040	19mm
WP273041	20mm
WP273042	21mm
WP273043	22mm
WP273044	23mm
WP273045	24mm
WP273046	25mm
WP273047	26mm
WP273048	27mm
WP273049	28mm
WP273050	29mm
WP273051	30mm
WP273052	32mm

DOUBLE OPEN WRENCH

- Forged steel
- Chrome plated, mirror polished



Model #	Description
WP273053	6x7mm
WP273054	8x9mm
WP273055	8x10mm
WP273056	10x11mm
WP273057	10x12mm
WP273058	12x13mm
WP273059	12x14mm
WP273060	14x15mm
WP273061	14x17mm
WP273062	16x17mm
WP273063	16x18mm

Model #	Description
WP273064	17x19mm
WP273065	18x19mm
WP273066	19x22mm
WP273067	20x22mm
WP273068	21x23mm
WP273069	22x24mm
WP273070	24x27mm
WP273071	25x28mm
WP273072	27x30mm
WP273073	30x32mm

DOUBLE OPEN WRENCH

- Chrome-vanadium steel
- Sand blasting and chrome plated



Model #	Description
WP273074	6x7mm
WP273075	8x9mm
WP273076	10x11mm
WP273077	12x13mm
WP273078	14x15mm
WP273079	16x17mm
WP273080	18x19mm

Model #	Description
WP273081	20x22mm
WP273082	21x23mm
WP273083	24x27mm
WP273084	25x28mm
WP273085	27x30mm
WP273086	30x32mm

DOUBLE RING WRENCH

- Forged steel
- Chrome plated, mirror polished



Model #	Description
WP273087	6x7mm
WP273088	8x9mm
WP273089	10x11mm
WP273090	12x13mm
WP273091	14x15mm
WP273092	16x17mm
WP273093	18x19mm

Model #	Description
WP273094	20x22mm
WP273095	21x23mm
WP273096	24x27mm
WP273097	25x28mm
WP273098	27x30mm
WP273099	30x32mm



DOUBLE RING WRENCH

- Chrome-vanadium steel
- Sand blasting and chrome plated



Model #	Description
WP273100	6x7mm
WP273101	8x9mm
WP273102	10x11mm
WP273103	12x13mm
WP273104	14x15mm
WP273105	16x17mm
WP273106	18x19mm

Model #	Description
WP273107	20x22mm
WP273108	21x23mm
WP273109	24x27mm
WP273110	25x28mm
WP273111	27x30mm
WP273112	30x32mm

RATCHETING COMBINATION WRENCH

- CR-V steel and heat treated
- Chrome-plated surface
- 72-tooth ratchet head for smoother rotation

MM



Model #	Description
WP273124	6mm
WP273125	8mm
WP273126	9mm
WP273127	10mm
WP273128	11mm
WP273129	12mm
WP273130	13mm
WP273131	14mm
WP273132	15mm
WP273133	16mm

Model #	Description
WP273134	17mm
WP273135	18mm
WP273136	19mm
WP273137	21mm
WP273138	22mm
WP273139	24mm
WP273140	27mm
WP273141	30mm
WP273142	32mm

FLEXIBLE RATCHETING COMBINATION WRENCH

- CR-V steel and heat treated
- Chrome-plated surface
- 72-tooth ratchet head for smoother rotation
- 180 degree steering at ratchet end



Model #	Description
WP273163	8mm
WP273164	9mm
WP273165	10mm
WP273166	11mm
WP273167	12mm
WP273168	13mm

Model #	Description
WP273169	14mm
WP273170	15mm
WP273171	16mm
WP273172	17mm
WP273173	18mm
WP273174	19mm

5PC COMBINATION WRENCH SET

- Chrome-vanadium steel
- Sand blasting and chrome plated

MM



Model #	Description
WP202500	6, 8, 10, 12, 15mm

6PC COMBINATION WRENCH SET

- CR-V steel and heat treated for strength and durability
- Sand blasting and chrome plated

MM



Model #	Description
WP202501	8, 10, 12, 14, 16, 18mm

8PC DOUBLE RING END WRENCH SET

- CR-V steel and heat treated
- Sand blasting and chrome plated
- Plastic rack for easy storage

MM



Model #	Description
WP202509	6x7, 8x9, 10x11, 12x13, 14x15, 16x17, 18x19, 20x22mm

9PC DOUBLE OPEN WRENCH SET

- Chrome-vanadium steel
- Sand blasting and chrome plated

MM



Model #	Description
WP202505	6x7, 8x9, 10x11, 12x13, 14x15, 16x17, 18x19, 20x22, 21x23mm

8PC DOUBLE OPEN WRENCH SET

- CR-V steel and heat treated
- Sand blasting and chrome plated

MM



Model #	Description
WP202506	6x7, 8x9, 10x11, 12x13, 14x15, 16x17, 18x19, 20x22mm

7PC RATCHETING COMBINATION WRENCH SET

- CR-V steel and heat treated
- Chrome-plated and polished surface
- 72-tooth ratchet head
- Plastic rack for easy storage



Model #	Description
WP202511	10, 11, 12, 13, 14, 15, 16mm

9PC COMBINATION WRENCH SET

- CR-V steel and heat treated
- Sand blasting and chrome plated
- Hanging bag packaging

MM



Model #	Description
WP202502	8, 10, 11, 12, 13, 14, 15, 17, 19mm

16PC COMBINATION WRENCH SET

- CR-V steel and heat treated
- Sand blasting and chrome plated
- Hanging bag packaging

MM



Model #	Description
WP202503	6, 8, 10, 11, 12, 13, 14, 15, 17, 19, 21, 22, 24, 27, 30, 32mm

23PC COMBINATION WRENCH SET

- CR-V steel and heat treated
- Sand blasting and chrome plated
- Hanging bag packaging

MM



Model #	Description
WP202504	6, 7, 8, 9, 10, 11, 12, 13, 14, 15, 16, 17, 18, 19, 20, 21, 22, 23, 24, 25, 27, 30, 32mm

12PC DOUBLE OPEN WRENCH SET

- CR-V steel and heat treated
- Sand blasting and chrome plated
- Hanging bag packaging

MM



Model #	Description
WP202507	6x7, 8x9, 10x11, 12x13, 14x15, 16x17, 18x19, 20x22, 21x23, 24x27, 25x28, 30x32mm

12PC DOUBLE RING WRENCH SET

- CR-V steel and heat treated
- Sand blasting and chrome plated
- Hanging bag packaging

MM



Model #	Description
WP202510	6x7, 8x9, 10x11, 12x13, 14x15, 16x17, 18x19, 20x22, 21x23, 24x27, 25x28, 30x32mm

8PC FLEXIBLE RATCHETING COMBINATION WRENCH SET

- CR-V steel and matt chrome plated
- 72-teeth

MM



Model #	Description
WP202521	9, 10, 11, 12, 13, 14, 15, 17mm

7PC RATCHET COMBINATION WRENCH SET

- CR-V steel and heat treated
- Sand blasting and chrome plated
- Hanging bag packaging

MM



Model #	Description
WP202562	8, 10, 11, 12, 13, 14, 17mm



DOUBLE RING RATCHET WRENCH SET

- Cr-V
- 1pc 14x19mm ring ratchet wrench
- 6pcs 6PT socket size:8,10,12,13,15,17mm

MM



Model #	Description
WP202567	7pc

DOUBLE RING RATCHET WRENCH SET

- Cr-V
- 1pc 14x19mm double ring and double drive ratchet wrench
- 6pcs 6PT Socket size:8,10,12,13,15,17mm

MM



Model #	Description
WP202568	7pc

DOUBLE RING AND DOUBLE FLEXIBLE RATCHET WRENCH SET

- Cr-V
- 1pc 14x19mm double ring and double flexible ratchet wrench
- 6pcs 6PT socket size:8,10,12,13,15,17mm

MM



Model #	Description
WP202569	7pc

11PC DOUBLE RING AND DOUBLE FLEXIBLE RATCHET WRENCH SET

- Cr-V
- 1pc 14x19mm double ring and double flexible ratchet wrench
- 6pcs 6PT socket size:8,9,10,11,12,13,15,16,17,18mm

MM



Model #	Description
WP202570	11pc

9PC RATCHET COMBINATION WRENCH SET

- Cr-V
- 9pcs ratchet combination wrench size:8,9,10,11,12,13,15,16,17,18mm

MM



Model #	Description
WP202571	9pc



DOUBLE DRIVE RATCHET HANDLE



3/8" DRIVE

Cr-Mo D Head

Ergonomic Handle
With slip-resistant rubber grip



CR-V Forged Steel



Model #	Description
WP271013	3/8" Drive; 48T

RATCHET HANDLE

OFFSET DESIGN



Cr-Mo D Head

Chrome Steel

Tri-color Handle
Ergonomic rubber grip

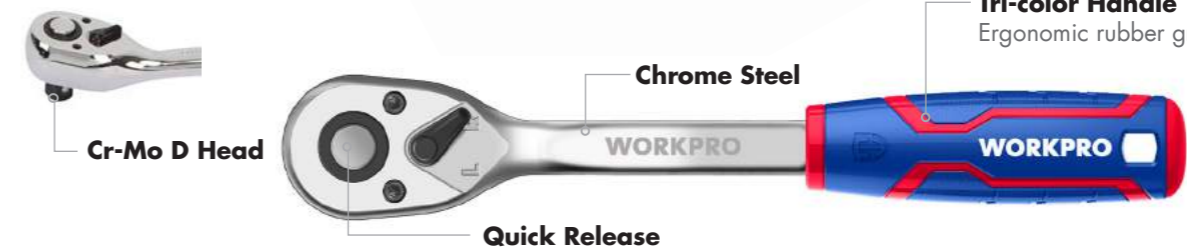

Quick Release



Model #	Description
WP271010	1/4" Drive; 72T
WP271011	3/8" Drive; 72T
WP271012	1/2" Drive; 72T

RATCHET HANDLE

- Chrome steel
- Matt chrome plated
- Quick release
- Tri-color anti-slip handle



Model #	Description
WP271007	1/4" Drive; 45T
WP271008	3/8" Drive; 45T
WP271009	1/2" Drive; 45T

RATCHET HANDLE

- Chrome steel, full polished
- Comfortable grip handle
- Quick release



Model #	Description
WP271021	1/4" Drive; 43T
WP271022	3/8" Drive; 41T
WP271023	1/2" Drive; 45T

TEARDROP RATCHET HANDLE

- Chrome steel
- Comfortable grip handle
- Quick release, Forward/reverse 90T gear



Model #	Description
WP271004	1/4" Drive; 90T
WP271005	3/8" Drive; 90T
WP271006	1/2" Drive; 90T

RATCHET HANDLE

- Forged steel, chrome plated
- Comfortable grip handle
- Forward/ reverse ratchet



Model #	Description
WP271001	1/4" Drive; 43T
WP271002	3/8" Drive; 39T
WP271003	1/2" Drive; 45T

3-IN-1 RATCHET HANDLE



Model #	Description
WP271014	1/4", 3/8", 1/2" Drive; 72T

TORQUE WRENCH

- Aluminum alloy handle
- Prefabricated, torque can be set
- 40CR ratchet head, Cr-Mo D head, chrome steel
- 72-tooth ratchet structure

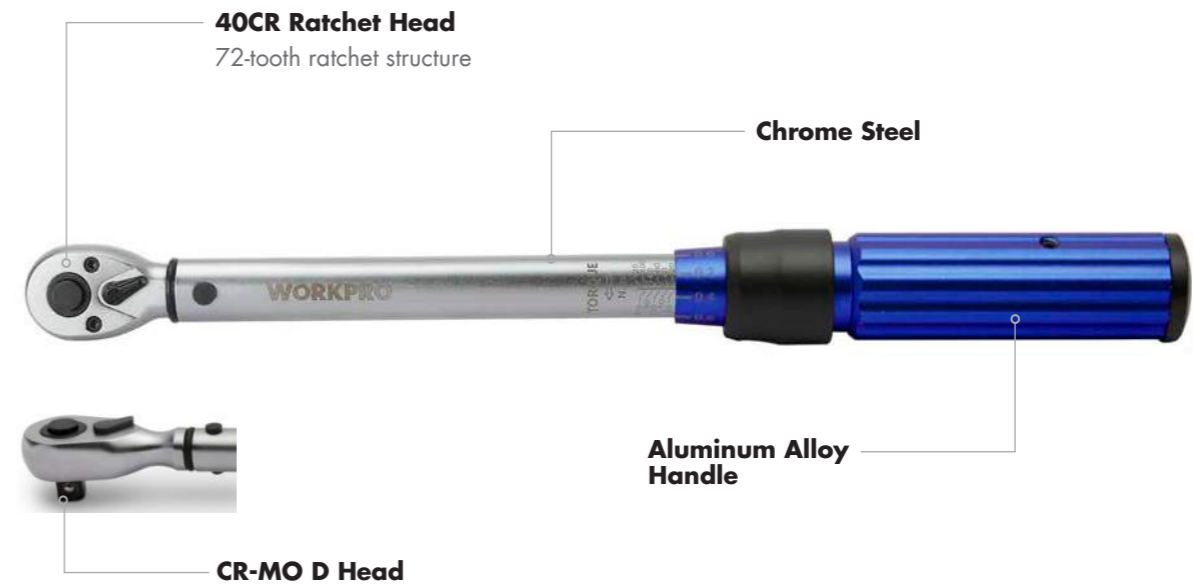

Model #	Description
WP271018	1/4" Drive; 72T; 5-25N.M
WP271019	3/8" Drive; 72T; 20-120N.M
WP271020	1/2" Drive; 72T; 40-220N.M

TORQUE WRENCH

- All-steel handle, 40CR D head
- Heat treated, electroplating on the handle surface
- 24-tooth ratchet structure



Model #	Description
WP271015	1/4" Drive; 24T; 5-25N.M
WP271016	3/8" Drive; 24T; 19-110N.M
WP271017	1/2" Drive; 24T; 28-210N.M



STANDARD SOCKET, 6PT



Matt Chrome Plated

CR-V Steel

6-Point Socket Opening

Provides an exact fit and maximum contact for hex fasteners

Large, Stamped Marking

Clearly visible size numbers with extra-deep outline

Secure Drive Tool Engagement



Model #	Description
WP274001	4mm
WP274002	5mm
WP274003	6mm
WP274004	7mm
WP274005	8mm
WP274006	9mm

Model #	Description
WP274007	10mm
WP274008	11mm
WP274009	12mm
WP274010	13mm
WP274011	14mm

DEEP SOCKET, 6PT

- CR-V steel and heat treated
- Matt chrome plated
- With anti-slip rolling pattern



Model #	Description
WP274012	4mm
WP274013	5mm
WP274014	6mm
WP274015	7mm
WP274016	8mm
WP274017	9mm
WP274018	10mm
WP274019	11mm
WP274020	12mm
WP274021	13mm
WP274022	14mm

STANDARD SOCKET, 12PT

- CR-V steel and heat treated
- Matt chrome plated
- With anti-slip rolling pattern



Model #	Description
WP274023	4mm
WP274024	5mm
WP274025	6mm
WP274026	7mm
WP274027	8mm
WP274028	9mm
WP274029	10mm
WP274030	11mm
WP274031	12mm
WP274032	13mm
WP274033	14mm

STANDARD SOCKET, 6PT

- CR-V steel and heat treated
- Matt chrome plated
- With anti-slip rolling pattern



Model #	Description
WP274034	6mm
WP274035	7mm
WP274036	8mm
WP274037	9mm
WP274038	10mm
WP274039	11mm
WP274040	12mm
WP274041	13mm
WP274042	14mm
WP274043	15mm

Model #	Description
WP274044	16mm
WP274045	17mm
WP274046	18mm
WP274047	19mm
WP274048	20mm
WP274049	21mm
WP274050	22mm
WP274051	23mm
WP274052	24mm



DEEP SOCKET, 6PT

- CR-V steel and heat treated
- Matt chrome plated
- With anti-slip rolling pattern



Model #	Description
WP274053	8mm
WP274054	9mm
WP274055	10mm
WP274056	11mm
WP274057	12mm
WP274058	13mm
WP274059	14mm
WP274060	15mm
WP274061	16mm

Model #	Description
WP274062	17mm
WP274063	18mm
WP274064	19mm
WP274065	20mm
WP274066	21mm
WP274067	22mm
WP274068	23mm
WP274069	24mm

STANDARD SOCKET, 12PT

- CR-V steel and heat treated
- Matt chrome plated
- With anti-slip rolling pattern



Model #	Description
WP274070	6mm
WP274071	7mm
WP274072	8mm
WP274073	9mm
WP274074	10mm
WP274075	11mm
WP274076	12mm
WP274077	13mm
WP274078	14mm
WP274079	15mm

Model #	Description
WP274080	16mm
WP274081	17mm
WP274082	18mm
WP274083	19mm
WP274084	20mm
WP274085	21mm
WP274086	22mm
WP274087	23mm
WP274088	24mm

STANDARD SOCKET, 6PT

- CR-V steel and heat treated
- Matt chrome plated
- With anti-slip rolling pattern



Model #	Description
WP274089	8mm
WP274090	9mm
WP274091	10mm
WP274092	11mm
WP274093	12mm
WP274094	13mm
WP274095	14mm
WP274096	15mm
WP274097	16mm
WP274098	17mm
WP274099	18mm
WP274100	19mm

Model #	Description
WP274101	20mm
WP274102	21mm
WP274103	22mm
WP274104	23mm
WP274105	24mm
WP274106	25mm
WP274107	26mm
WP274108	27mm
WP274109	28mm
WP274110	29mm
WP274111	30mm
WP274112	32mm

DEEP SOCKET, 6PT

- CR-V steel and heat treated
- Matt chrome plated
- With anti-slip rolling pattern



Model #	Description
WP274113	8mm
WP274114	9mm
WP274115	10mm
WP274116	11mm
WP274117	12mm
WP274118	13mm
WP274119	14mm
WP274120	15mm
WP274121	16mm
WP274122	17mm
WP274123	18mm
WP274124	19mm

Model #	Description
WP274125	20mm
WP274126	21mm
WP274127	22mm
WP274128	23mm
WP274129	24mm
WP274130	25mm
WP274131	26mm
WP274132	27mm
WP274133	28mm
WP274134	29mm
WP274135	30mm
WP274136	32mm



STANDARD SOCKET, 12PT

- CR-V steel and heat treated
- Matt chrome plated
- With anti-slip rolling pattern
- 12-corner hole easier for putting on the nut



Model #	Description
WP274137	8mm
WP274138	9mm
WP274139	10mm
WP274140	11mm
WP274141	12mm
WP274142	13mm
WP274143	14mm
WP274144	15mm
WP274145	16mm
WP274146	17mm
WP274147	18mm
WP274148	19mm

Model #	Description
WP274149	20mm
WP274150	21mm
WP274151	22mm
WP274152	23mm
WP274153	24mm
WP274154	25mm
WP274155	26mm
WP274156	27mm
WP274157	28mm
WP274158	29mm
WP274159	30mm
WP274160	32mm

SPARK PLUG SOCKET

- CR-V steel and heat treated
- Matt chrome plated
- With anti-slip rolling pattern
- For spark plugs disassembling and assembling



Model #	Description
WP274161	3/8" Drive; 16mm
WP274162	3/8" Drive; 21mm
WP274163	3/8" Drive; 5/8"
WP274164	3/8" Drive; 13/16"
WP274165	1/2" Drive; 16mm
WP274166	1/2" Drive; 21mm
WP274167	1/2" Drive; 5/8"
WP274168	1/2" Drive; 13/16"

UNIVERSAL SOCKET SET

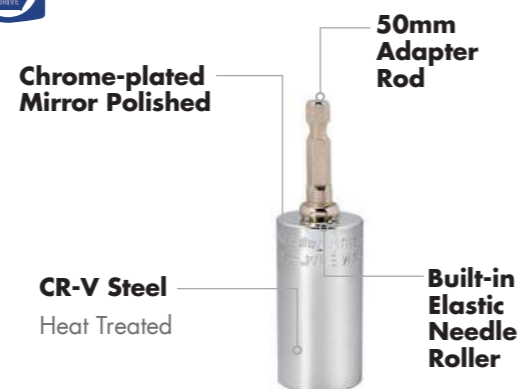

Model #	Description
WP202517	7-19mm

UNIVERSAL JOINT

- CR-V steel and heat treated
- Matt chrome plated
- The head can be turned arbitrarily, and it can be used with sockets, extension rods, etc.



Model #	Description
WP275001	1/4" Drive
WP275002	3/8" Drive
WP275003	1/2" Drive

UNIVERSAL JOINT SET

- 3PC
- Chrome-vanadium steel
- Matt chrome plated
- The head can be turned arbitrarily, and it can be used with sockets, extension rods, etc.



Model #	Description
WP202518	1/4", 3/8", 1/2"

ADAPTER SET

- 4PC
- Chrome-vanadium steel
- Matt chrome plated
- For the conversion of ratchet and different sockets



Model #	Description
WP202519	1/4-3/8", 3/8-1/4", 3/8-1/2", 1/2-3/8"

3 WAY ADAPTOR

- Chrome-vanadium steel
- Matt chrome plated



Model #	Description
WP275008	3/8"F-1/4"M
WP275009	3/8"F-1/2"M
WP275010	1/2"F-3/8"M

BIT ADAPTOR

- Chrome-vanadium steel
- Matt chrome plated
- Used to connect 6.35mm hex bit



Model #	Description
WP275011	1/4"

EXTENSION BAR

- Chrome-vanadium steel
- Matt chrome plated
- With steering function
- Use with sockets, adapters, F rods, etc.



Model #	Description
WP275020	1/4"x2"
WP275021	1/4"x3"
WP275022	1/4"x4"
WP275023	1/4"x6"
WP275024	3/8"x3"
WP275025	3/8"x5"

Model #	Description
WP275026	3/8"x6"
WP275027	3/8"x10"
WP275028	1/2"x3"
WP275029	1/2"x5"
WP275030	1/2"x10"

SLIDING T-BAR

- Chrome-vanadium steel
- Matt chrome plated



Model #	Description
WP275012	1/4"
WP275013	3/8"
WP275014	1/2"

L-SHAPE SOCKET BREAKER

- Chrome-vanadium steel
- Matt chrome plated
- With knurled handle, non-slip
- Used with sockets, adapters, and extension bars



Model #	Description
WP275015	1/2" Drive; 250x50 mm

F-SHAPE BREAKER BAR

- Chrome steel
- Matt chrome plated
- Gourd tail handle, comfortable to hold
- Use with Sockets, adapters, and extension bars



Model #	Description
WP275018	1/4"x150mm
WP275019	1/2"x380mm

1/4" DR. T-HANDLE

MULTI-FUNCTION SPEED SLIDING T-HANDLE

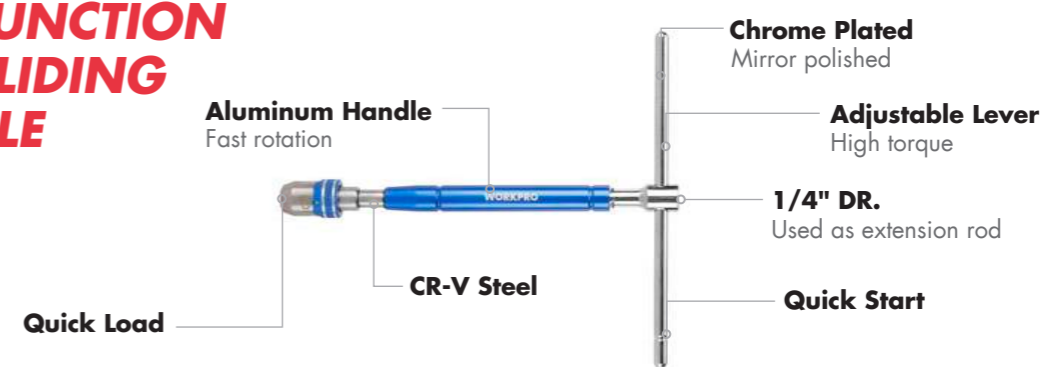

Model #	Description
WP275016	1/4" Drive

3/8" DR. T-HANDLE

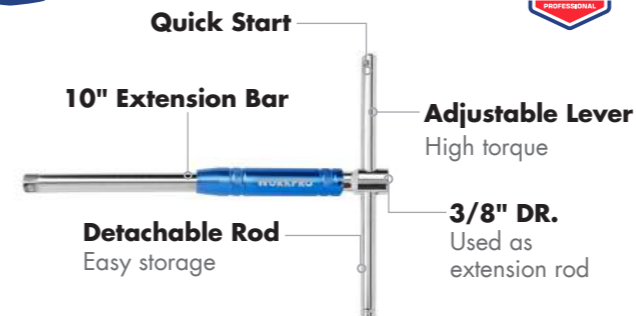

Model #	Description
WP275017	3/8" Drive

1/4" SOCKET DRIVE HANDLE

- Chrome-vanadium steel
- Matt chrome plated, rust resistance
- Monochrome PP Handle



Model #	Description
WP275032	1/4" Drive

1/4" DR. FINGER RATCHET

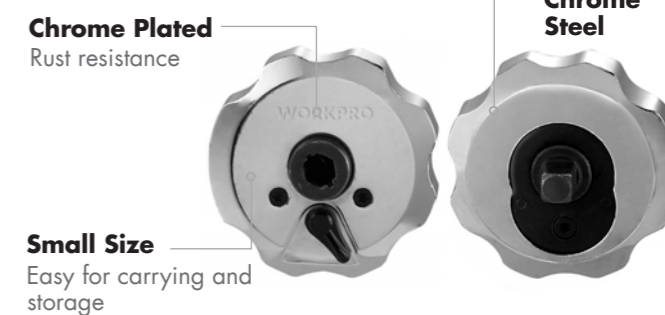

Model #	Description
WP275031	1/4" Drive



FASTENING TOOLS

- SCREWDRIVER
- HEX KEY
- CAULKING GUN
- STAPLE GUN
- RIVET GUN

SPEED UP YOU WORK WITH PATEDED DOUBLE DRIVE

Bit Storage Provides Easy Access

Forward/Reverse
Easy to Change Ratcheting Directions.

Super Magnetic Force Transfer Holds Screw on The Bit Tip

HOLD SOCKET, TRY DOUBLEDRIIVE

2X-FASTER THAN STANDARD RATCHETING



Model #	Name	Description
WP221069	6-IN-1 DOUBLE DRIVE FULL SIZE SCREWDRIVER	6pcs 1" Bits: PH1,PH2,PH3; SL3, 5, 6mm
WP221070	9-IN-1 DOUBLE DRIVE PRECISIONS CREWDRIVER	9pcs 4mm Bits: PH000,PH00,PH0,PH1;SL2, 2.5, 3, 4mm;T5
WP221071	6-IN-1 DOUBLE DRIVE STUBBY SCREWDRIVER	6pcs 1" Bits: PH1,PH2,PH3; SL3, 5, 6mm
WP221072	7-IN-1 DOUBLE DRIVE T-HANDLE SCREWDRIVER	7pcs 1" Bits: PH1,PH2*2,PH3; SL3, 5, 6mm

38-IN-1 DOUBLE DRIVE STUBBY RATCHET SCREWDRIVER SET

2X FASTER **DUAL DRIVE**

Ergonomic Handle
With slip resistant rubber grip

CR-V Bits

Convenient Thumb Switch
Reverse gear drive

Model #	Description
WP221050	SL1/8, SL3/16x2, SL1/4x2, SL9/32; PH0, PH1x2, PH2x2, PH3; PH2x6; T10, T15, T20, T25, T27, T30; H3/32, H1/8, H5/32, H3/16, H7/32, H1/4; S0, S1x2, S2x2, S3

12PC DOUBLE DRIVE PRECISION RATCHET SCREWDRIVER SET

2X FASTER **DUAL DRIVE**

- Carbon steel forged with black polished surface
- Fiberglass handle, sturdy and durable

Model #	Description
WP221051	1.5mm, 2mm, 2.5mm, 3mm; PH000, PH00x2, PH0, PH1; T5, T6

28PC DOUBLE DRIVE RATCHET SCREWDRIVER SET

- CR-V steel
- Ergonomic handle with slip resistant rubber grip
- Convenient thumb switch reverse gear drive



MM

2X FASTER **DUAL DRIVE**



Model #	Description
WP221053	20PC 1" CR-V bits: PH0, PH1, PH2X3, PH3; SL1/8", 3/16", 1/4"; H3/32, H1/8, H5/32, H3/16; S3, S2, S1; T10, T15, T20, T25; 6PC CR-V Sockets: size: 3/16x36mm, 1/4x36mm, 9/32x36mm, 5/16x36mm, 11/32x36mm, 3/8x38mm 1PC flexible extension bar; 1PC 2" PH2 try me bit

29PC DOUBLE DRIVE RATCHET SCREWDRIVER SET

- CR-V steel bits
- Ergonomic handle with slip resistant rubber grip
- Convenient thumb switch reverse gear drive



2X FASTER **DUAL DRIVE**



Model #	Description
WP221052	20PC 1" CR-V bits, Phillips: PH0, PH1, PH2X3, PH3; Slotted: 1/8", 3/16", 1/4"; Hex: H3/32, H1/8, H5/32, H3/16; Square: S3, S2, S1; Torx: T10, T15, T20, T25; 6PC CR-V Sockets: size: 3/16x36mm, 1/4x36mm, 9/32x36mm, 5/16x36mm, 11/32x36mm, 3/8x38mm 1PC flexible extension bar; 1PC 2" PH2 try me bit

DOUBLE DRIVE T-HANDLE RATCHETING SCREWDRIVER SET

- CR-V steel bits
- Ergonomic handle with slip resistant rubber grip



2X FASTER **DUAL DRIVE**



Model #	Description
WP221054	SL1.5, SL2, SL2.5, SL3; PH000, PH00, PH0, PH1; T5, T6, T7, T8, T9, T10; H1.5, H2.0, H2.5; PZ00, PZ0, PZ1

32PC 6X-SPEED DOUBLE DRIVE SCREWDRIVER SET

- CR-V steel
- Ergonomic handle with slip resistant rubber grip
- 6x faster than standard ratcheting



6X SPEED RATCHET **DUAL DRIVE**



Model #	Description
WP221055	SL3, SL5, SL6x2PC; PH0, PH1, PH2x3PC, PH3; T10, T15, T20, T25, T30; H2, H3, H4, H5, H6; S0, S1, S2, S3; PH0, PH00, PH000, 2.0mm, 2.5mm, 3.0mm

14-IN-1 QUICK-LOAD PRECISION SCREWDRIVER SET



QUICK LOAD

Auto-locking
Locks virtually any 4mm hex shank accessory



Rubberized, Ergonomic Grip
Gives higher torque output



Spinning Cap
Allows for easier and quicker fastening



Model #	Description
WP221057	7PC 3" double-ended S/D shafts: PH000/ SL1.5, PH00/ SL2, PH0/ SL2.5, PH1/ SL3, T6/ T7, T8/T9, H1.5/H2

12-IN-1 QUICK-LOAD SCREWDRIVER SET

- Auto-locking, one-handed bit loading locks virtually any 6.35mm hex shank accessory
- Rubberized, ergonomic grip gives higher torque output



QUICK LOAD



Model #	Description
WP221058	6PC 11cm double-ended screwdriver shafts: SL4-5&SL6-8, PH1&PH3, PH2&S2, S1&S3, T10&T15, T20&T25

10-IN-1 RATCHETING QUICK-LOAD SCREWDRIVER SET

- Auto-locking, one-handed bit loading locks virtually any 6.3mm hex shank accessory
- Rubberized, ergonomic grip gives higher torque output



QUIK LOAD



Model #	Description
WP221059	5PC 11cm double ended screwdriver shafts: SL4-5&SL6-8, PH1&PH3, PH2&S2, S1 & S3, T10&T15

6-IN-1 TELESCOPIC SCREWDRIVER SET

- High quality S2 double ended bit shaft
- Quick-load ratchet mechanism provides one-handed bit loading lock
- Anti-slip bi-material handle



Model #	Description
WP221060	PH2-6mm, PH1-5mm, H5-H6

12-IN-1 QUICK-LOAD SCREWDRIVER SET

- S2 steel bits
- Quick-load ratchet mechanism provides one-handed bit loading lock
- Anti-slip bi-material handle



Model #	Description
WP221063	SL4mm&SL5mm, PH1&PH3, PH2&S2, S1&S3, T10&T15, T20XT25

CR-V SCREWDRIVER



Magnetic Tip

Quick Twisting Knurling
Bit $\phi \geq 5\text{mm}$

CR-V Steel

Tri-color Handle
Comfortable grip

Model #	Description
WP221013	3x75mm
WP221014	4x100mm
WP221015	5.5x75mm
WP221016	5.5x100mm
WP221017	5.5x150mm
WP221018	Parallel screwdriver 5.5x150mm
WP221019	6.5x100mm
WP221020	6.5x150mm
WP221021	6.5x200mm
WP221022	8x150mm
WP221023	8x200mm
WP221024	6.5x38mm

Model #	Description
WP221025	PH0x75mm
WP221026	PH1x75mm
WP221027	PH1x100mm
WP221028	PH1x150mm
WP221029	PH2x100mm
WP221030	PH2x150mm
WP221031	PH2x200mm
WP221032	PH3x150mm
WP221033	PH3x200mm
WP221034	PH2x38mm

Model #	Description
WP221035	PZ0x75mm
WP221036	PZ1x100mm
WP221037	PZ2x100mm
WP221038	PZ3x150mm

Model #	Description
WP221039	T10x100mm
WP221040	T15x100mm
WP221041	T20x100mm
WP221042	T25x100mm
WP221043	T27x100mm
WP221044	T30x100mm
WP221045	T40x125mm

6.35MM(1/4" DR.) MAGNETIC BIT HOLDER

- Chrome plated magnetic bit holder
- Anti-slip tri-color handle
- Accept H6.35mm/ 1/4" bits



Model #	Description
WP221049	$\phi 10 \times 75\text{mm}$

6-IN-1 SCREWDRIVER



CR-V Bits

Tri-color Handle
Anti-slip

Phillips-slotted
Allows screwing with $\phi 1.5-4\text{mm}$
L type hook screws

Model #	Description
WP221046	PH1, PH2, 5mm, 6mm

2PC CR-V SCREWDRIVER SET

- Chrome-vanadium blade
- Black magnetic tip
- Ergonomic comfort grip handle



Model #	Description
WP200503	2PC: 6.5x150mm, PH2x150mm

6PC CR-V SCREWDRIVER SET

- CR-V Steel
- Black finish blade with magnetic tip
- Anti-rust chrome plated
- Anti-slip tri-color handle



Model #	Description
WP200504	6PC: 6.5x150mm, 5.5x100mm, 3x75mm; PH1x100mm, PH2x100mm, PH0x75mm

8PC CR-V SCREWDRIVER SET

- CR-V Steel
- Black finish blade with magnetic tip
- Anti-rust chrome plated
- Anti-slip tri-color handle



Model #	Description
WP200505	8PC: 5.5x100mm, 6.5x150mm, 3x75mm, 6.5x38mm; PH1x100mm, PH2x150mm, PH2x38mm, PH0x75mm

18PC CR-V SCREWDRIVER SET

- Chrome-vanadium blade
- Black magnetic tip
- Ergonomic comfort grip handle



Model #	Description
WP200506	8PC screwdrivers: 6.5x38mm, 5.5x100mm, 6.5x100mm, 8x150mm; PH1x100mm, PH2x38mm, PH2x100mm, PH3x150mm; 10PC precision screwdrivers: PH000, PH000, PH0; 1.5mm, 2mm, 2.5mm, 3mm; T7, T8, T9

7PC CR-V PRECISION SCREWDRIVER SET (PHILLIPS +SLOTTED)

- CR-V steel blade with magnetic tip
- Anti-slip tri-color handle
- Rotary cap

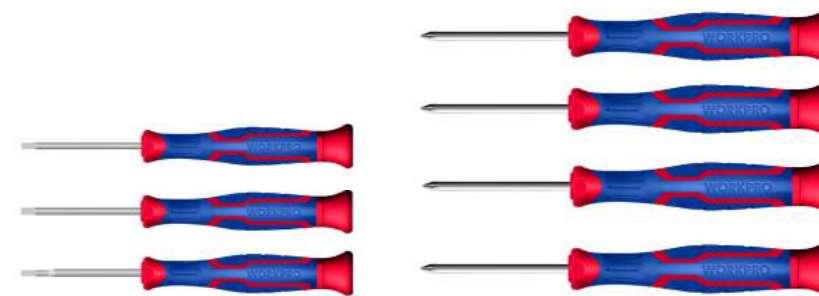

Model #	Description
WP200509	7PC: PH000, PH00, PH0, SL1.5, 2, 2.5, 3x50mm

7PC CR-V PRECISION SCREWDRIVER SET (TORX)

- CR-V steel blade with magnetic tip
- Anti-slip tri-color handle
- Rotary cap

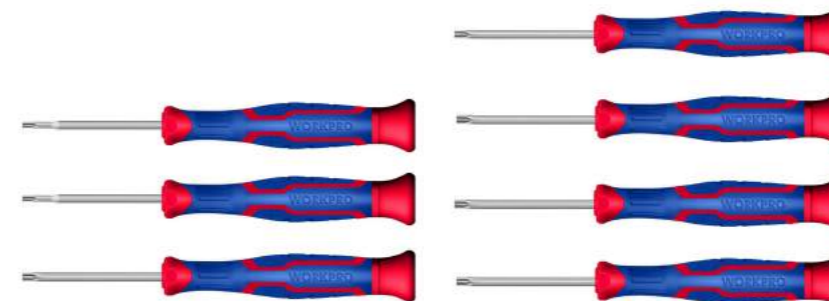

Model #	Description
WP200510	7PC: T4, 5, 6, 7, 8, 9, 10x50mm

100PC SCREWDRIVER SET

- CR-V steel
- Black finish blade with magnetic tip
- Anti-rust chrome plated



Model #	Description
WP200507	8PC precision screwdrivers: 1.5mm, 2.5mm, PH00, PH0, T6, T7, T8, T9 1PC bits holder
	60PC 25mm CR-V bits: SL3x2, 4x2, 5x3, 6x3; PH0X2, PH1X3, PH2X3, PH3X2; PZ0X2, PZ1X3, PZ2X3, PZ3X2; T7, T8, T9, T10, T15, T20, T25, T27, T30, T40; H2, 4, 3x2, 5x2, 6x2, 5.5x2; SOX2, S1X3, S2X3, S3X2
WP200507	22PC screwdrivers: 3x75, 4x100, 5.5x75, 5.5x100, 5.5x150, 6.5x100, 6.5x150, 8x150, PH0x75, PH0x100, PH1x75, PH1x100, PH1x150, PH2x100, PH2x150, PH3x150, T10x100, T15x100, T20x100, SOx100, S1x100, S2x100
	1PC 100mm owl
	2PC offset screwdrivers: PH1&5, PH2&6
	6PC socket nuts: 5,6,7,8,9,10



45PC SCREWDRIVER SET

- Anti-slip bi-material handle
- Super convenient organizing holder included
- Magnetic tip helps aid in securing the screw tight places



Model #	Description
WP200512	7PC screwdrivers: 3.5x75, 5.5x100, 6.5x125, 8x150, PH0x75, PH1x100, PH2x125 1PC screwdriver bits holder 10PC precision screwdriver: T5, T6, T7, T8, T9, T10, PH00, PH0, 2.5, 3 16PC bits (3, 4, 5, 6, PH0, PH1, PH2, PH3, H5, H6, T10, T15, T20, T25, T27, T30) 1PC bit adaptor 9PC 1/4" sockets: 5, 6, 7, 8, 9, 10, 11, 12, 13 1PC plastic rack

56PC SCREWDRIVER AND BITS SET

- CR-V steel chrome-plated screwdrivers
- 1PC magnetizer/demagnetizer
- 1PC blow mould case



Model #	Description
WP200518	8pc precision screwdriver: SL1.5x50, 2.0x50, 2.5x50, PH00x50, PH0x50mm, PH1x50mm, T9, T10; 40pc 25mm bits: PH0, PH1, PH2X3, PH3, H3, H4, H5, H6; SL3, 4, 5, 6, 7, T10, T15, T20, T25, AD; PH1, PH2X4, PH3, PZ0, PZ1, PZ2, PZ3; SOX2, S1X2, S2X4, S3X2 6pc screwdriver: SL5.5x75mm, 6.5x100mm; PH2x100mm, PH3x150mm 1pc bit driver 10x75mm

CR-V SCREWDRIVER



Model #	Description
WP221001	3x75mm
WP221002	5.5x100mm
WP221003	6.5x100mm
WP221004	6.5x150mm
WP221005	8x150mm
WP221006	6.5x38mm
WP221007	PH0x75mm
WP221008	PH1x100mm
WP221009	PH2x100mm
WP221010	PH2x150mm
WP221011	PH3x150mm
WP221012	PH2x38mm

6.35MM(1/4" DR.) MAGNETIC BIT HOLDER

- Anti-slip handle
- Chrome plated magnetic bit holder
- Accept H6.35 or 1/4" bits



Model #	Description
WP221068	φ10x75mm

6-IN-1 SCREWDRIVER



Model #	Description
WP221066	5mm, 6mm, PH1, PH2

2PC CR-V SCREWDRIVER SET

- CR-V Steel
- Black finish blade with magnetic tip
- Anti-rust chrome plated



Model #	Description
WP200500	2PC; Includes 1pc 6.5x150mm , 1pc PH2x150mm

6PC CR-V SCREWDRIVER SET

- Drop-forged CR-V steel long blade
- Blade edge honed
- Steel butt designed for heavy pounding
- Ergonomic grip handle



Model #	Description
WP200501	6PC: SL3x75, 5.5x100, 6.5x150mm; PH0x75, PH1x100, PH2x100mm

8PC CR-V SCREWDRIVER SET

- Drop-forged CR-V steel long blade
- Blade edge honed
- Steel butt designed for heavy pounding
- Ergonomic grip handle



Model #	Description
WP200502	8PC: SL3x75, 5.5x100, 6.5x150, 6.5x38mm; PH0x75, PH1x100, PH2x150, PH2x38mm

56PC SCREWDRIVER AND BITS SET

- CR-V steel chrome-plated screwdrivers
- Carbon steel blade, chrome plated bit driver
- 1PC magnetizer/demagnetizer
- 1PC blow mould case



Model #	Description
WP200520	8pc precision screwdriver: SL1.5x50, 2.0x50, 2.5x50, PH00x50, PH0x50mm, PH1x50mm, T9, T10; 40pc 25mm bits: PH0, PH1, PH2X3, PH3, H3, H4, H5, H6; SL3, 4, 5, 6, 7, T10, T15, T20, T25, AD; PH1, PH2X4, PH3, PZ0, PZ1, PZ2, PZ3; SOX2, S1X2, S2X4, S3X2 6pcs screwdriver: SL5.5x75mm, 6.5x100mm; PH2x100mm, PH3x150mm 1pc bit driver 10x75mm

6PC PRECISION SCREWDRIVER SET

- Carbon steel blade with black finish
- Chrome-plated handle



Model #	Description
WP200508	6PC; Includes 1.4mm, 2.0mm, 2.4mm, 3.0mm, PH0, PH1

21PC PRECISION SCREWDRIVER SET

- Lightweight aluminum alloy handle
- Magnetic plastic box, easy to storage
- S2 steel bits



Model #	Description
WP200511	21PC; Includes T2, T3, T4, TT5, TT6, TT8, TT9, PH000, PH00, PH0, PH1, U2.6, W1.5, TT10, SL1.5, SL3.0, Y0.6, H2.0, P2, P5

4-IN-1 LIGHTED SCREWDRIVER

- CR-V bits
- 3PC high intensity LED bulbs
- One-handed ON/OFF switch
- Anti-slip BI-Material handle



Model #	Description
WP221047	PH1, PH2, 5mm, 6mm

13PC SCREWDRIVER BITS SET (METRIC)



3-position 72-tooth Precision Ratchet
Forward/ reverse/ lock



CR-V Steel Shaft
For greater strength and durability



Model #	Description
WP221061	14PC bits: 3mm, 4mm, 5mm, 6mm, H4, H5, H6, PH0, PH1, PH2, PH3, T15, T20, T25

PISTOL AUTO-LOAD RATCHETING SCREWDRIVER

- Auto-load ratcheting design for quick-change bits
- CR-V bits
- Pistol handle
- Color coated chambers

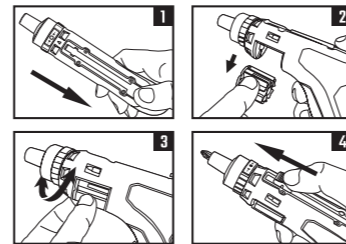

Model #	Description
WP221048	SL3, SL4, SL5, SL5.5, SL6x2; PH0x2, PH1x2, PH2x2; H3, H4, H5; S1, S2, S3; T8, T9, T10, T15, T20, T25

AUTO-LOAD RATCHETING SCREWDRIVER

- Auto-load mechanism for quick and easy bit changes
- Bit chamber includes: Slotted, Phillips, Torx, Hex and Square
- Chrome plated CR-V bits and shaft for durability



Model #	Description
WP221056	SL3, SL4, SL5, SL5.5, SL6.5x2PC; PH0x2, PH1x2, PH2x2; H3, H4, H5; S1, S2, S3; T8, T9, T10, T15, T20, T25

13PC SCREWDRIVER BITS SET (METRIC)

- CR-V bits
- Easily push down to open for taking bits



Model #	Description
WP221062	12PC 25mm bits (4mm, 5mm, 6mm, PH1, PH2, PH2, PH3, T10, T15, T20, T25, T30); 1PC 60mm magnetic bits holder

31PC SCREWDRIVER BITS SET

- CR-V bits
- Plastic box with belt clip, easy to carry



Model #	Description
WP200513	1PC 50mm magnetic bit holder 30PC bits: SL3, 4, 5, 5.5, 6, 7mm; PH0, PH1x2, PH2x2, PH3; PZ0, PZ1x2, PZ2x2, PZ3; T10, T15, T20, T25, T27, T30; H2, H3, H4, H5, H5.5, H6

MAGNETIZER/ DEMAGNETIZER

- Magnetization and Degaussing are integrated, convenient and quick
- Lightweight, easy to carry and storage



Model #	Description
WP221064	51x49x28.5mm

SCREWDRIVER

- CR-V bits
- Zinc body
- Stress release

CR-V Bits

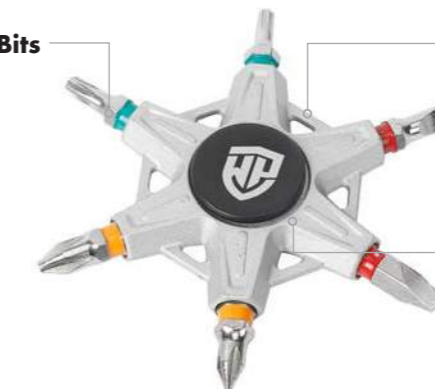

Rotate to Release Stress

Zinc Body

Model #	Description
WP221065	5, 6, PH1, PH2, T15, T20

18-IN-1 SNOWFLAKE MULTI TOOL

- Bottle opener, Philipps screwdriver, Slotted screwdriver
- Internal hexagon 3, 4, 5, 6, 7, 8mm
- External hexagon 6, 7, 8, 9, 10, 11, 12, 14mm
- 1PC cutting knife



Model #	Description
WP221067	Internal hexagon 3, 4, 5, 6, 7, 8mm; External hexagon 6, 7, 8, 9, 10, 11, 12, 14mm



8PC FOLDING HEX KEY SET (METRIC)

HIGH-STRENGTH HANDLE DESIGN

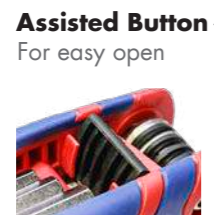

Assisted Button
For easy open

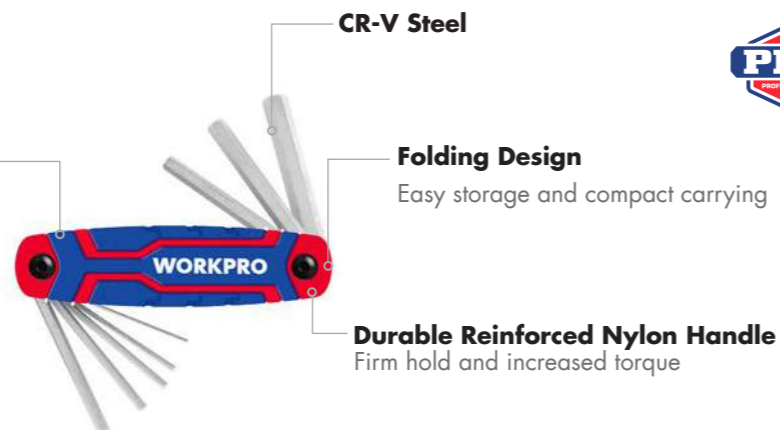

CR-V Steel

Folding Design
Easy storage and compact carrying

Durable Reinforced Nylon Handle
Firm hold and increased torque

Model #	Description
WP222019	8PC; H1.5, H2, H2.5, H3, H4, H5, H6, H8

9PC FOLDING HEX KEY SET (SAE)

- CR-V steel, hardened and tempered
- Press plate setting
- Durable reinforced nylon handle



Model #	Description
WP222022	9PC; H5/64", H3/32", H7/64", H9/64", H1/8", H5/32", H3/16", H7/32", H1/4"

8PC FOLDING BALL POINT HEX KEY SET (METRIC)

- CR-V steel, hardened and tempered
- Press plate setting
- Durable reinforced nylon handle



Model #	Description
WP222020	8PC; H1.5, H2, H2.5, H3, H4, H5, H6, H8

9PC FOLDING BALL POINT HEX KEY SET (SAE)

- CR-V steel, hardened and tempered
- Press plate setting
- Durable reinforced nylon handle



Model #	Description
WP222023	9PC; H5/64", H3/32", H7/64", H9/64", H1/8", H5/32", H3/16", H7/32", H1/4"

8PC FOLDING HEX KEY (METRIC)

- Light and strong aluminum structure handle
- CR-V steel, hardened and tempered



Model #	Description
WP222024	8PC; H1.5, H2, H2.5, H3, H4, H5, H6, H8

8PC FOLDING TORX KEY

- Light and strong aluminum structure handle
- CR-V steel, hardened and tempered



Model #	Description
WP222025	8PC; T8, T10, T15, T20, T25, T27, T30, T40

8PC FOLDING TORX KEY SET

- CR-V steel, hardened and tempered
- Press plate setting
- Durable reinforced nylon handle



Model #	Description
WP222021	8PC; T9, T10, T15, T20, T25, T27, T30, T40

9PC FOLDING HEX KEY (SAE)

- Light and strong aluminum structure handle
- CR-V steel, hardened and tempered



Model #	Description
WP222034	9PC; H5/64", H3/32", H7/64", H9/64", H1/8", H5/32", H3/16", H7/32", H1/4"

FOLDING SCREWDRIVER AND SOCKET SET

- 12-IN-1
- Aluminum structure handle
- CR-V steel, chrome plated



Model #	Description
WP222026	4PC sockets: 6, 8, 9, 10mm 7PC screwdrivers: PH0, PH1, PH2, PH3, SL3, SL4, SL5 1PC 1/4" holder

8PC FOLDING HEX KEY (METRIC)

- CR-V steel, hardened and tempered
- Anti-slip bi-material handle
- Black finish for rust resistance and long life



Model #	Description
WP222028	8PC; H1.5, H2, H2.5, H3, H4, H5, H6, H8

8PC FOLDING TORX KEY

- CR-V steel, hardened and tempered
- Anti-slip bi-material handle
- Black finish for rust resistance and long life



Model #	Description
WP222030	8PC; T9, T10, T15, T20, T25, T27, T30, T40

9PC FOLDING HEX KEY (SAE)

- CR-V steel, hardened and tempered
- Black finish for rust resistance and long life



Model #	Description
WP222032	9PC; H5/64", H3/32", H7/64", H1/8", H9/64", H5/32", H3/16", H7/32", H1/4"

9PC FOLDING HEX KEY (SAE)

- CR-V steel, hardened and tempered
- Anti-slip bi-material handle
- Black finish for rust resistance and long life



Model #	Description
WP222029	9PC; H5/64", H3/32", H7/64", H1/8", H9/64", H5/32", H3/16", H7/32", H1/4"

8PC FOLDING HEX KEY (METRIC)

- CR-V steel, hardened and tempered
- Black finish for rust resistance and long life



Model #	Description
WP222031	8PC; H1.5, H2, H2.5, H3, H4, H5, H6, H8

8PC FOLDING TORX KEY

- CR-V steel, hardened and tempered
- Black finish for rust resistance and long life



Model #	Description
WP222033	8PC; T9, T10, T15, T20, T25, T27, T30, T40

9PC EXTRA LONG ARM BALL POINT HEX KEY SET (METRIC)

EXTRA LONG & MAGNETIZABLE



Portable Rack
Easy to carry and storage



Heat-treated S2 Steel
For lasting strength and durability

Ball-Point Heads
25-degree entry angle, easy to operate in tight spaces

Extra Long Arm
Higher torque and extra reach

Chrome-Plated Surface
Anti-rust

Magnetized Design
Rub it into the grooves that produce the wrench magnetic force

Model #	Description
WP222035	H1.5, H2, H2.5, H3, H4, H5, H6, H8, H10

9PC EXTRA LONG ARM STAR-TORX KEY WRENCH SET

- S2 steel
- Anti-rust chrome plated surface
- Magnetized and Demagnetized Design
- Portable plastic rack with hanging holes



Model #	Description
WP222036	T10, T15, T20, T25, T27, T30, T40, T45, T50

9PC TORX KEY SET

- CR-V steel blade
- Chrome plated, anti-slip and anti-rust
- Powder coating handle



Model #	Description
WP222008	Long arm; T10, T15, T20, T25, T27, T30, T40, T45, T50

Model #	Description
WP222009	T10, T15, T20, T25, T27, T30, T40, T45, T50

9PC BALL POINT HEX KEY SET (METRIC)

- CR-V steel blade
- Chrome plated, anti-slip and anti-rust
- Powder coating handle



Model #	Description
WP222011	Long arm; H1.5, H2, H2.5, H3, H4, H5, H6, H8, H10

Model #	Description
WP222010	H1.5, H2, H2.5, H3, H4, H5, H6, H8, H10

9PC BALL POINT HEX KEY SET (SAE)

- CR-V steel blade
- Chrome plated, anti-slip and anti-rust
- Powder coating handle



Model #	Description
WP222013	Long arm; H1/16", 5/64", 3/32", 1/8", 5/32", 3/16", 1/4", 5/16", 3/8"

Model #	Description
WP222012	H1/16", H5/64", H3/32", H1/8", H5/32", H3/16", H1/4", H5/16", H3/8"

9PC HEX KEY SET (METRIC)

- CR-V steel blade
- Chrome plated, anti-slip and anti-rust
- Powder coating handle



Model #	Description
WP222015	Long arm; H1.5, H2, H2.5, H3, H4, H5, H6, H8, H10

Model #	Description
WP222014	H1.5, H2, H2.5, H3, H4, H5, H6, H8, H10

9PC HEX KEY SET (SAE)

- CR-V steel blade
- Chrome plated, anti-slip and anti-rust
- Powder coating handle



Model #	Description
WP222017	Long arm; H1/16", 5/64", 3/32", 1/8", 5/32", 3/16", 1/4", 5/16", 3/8"

Model #	Description
WP222016	H1/16", 5/64", 3/32", 1/8", 5/32", 3/16", 1/4", 5/16", 3/8"

9PC TORX KEY SET

- CR-V steel blade
- Drilled tips for tamper-resistant screws
- Portable plastic rack with hanging holes

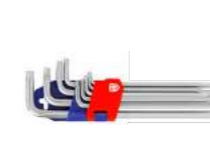

Model #	Description
WP222002	T10, T15, T20, T25, T27, T30, T40, T45, T50
WP222003	Long arm; T10, T15, T20, T25, T27, T30, T40, T45, T50

9PC HEX KEY SET (METRIC)

- CR-V steel blade
- Chrome plated
- Drilled tips for tamper-resistant screws
- Portable plastic rack



Model #	Description
WP222004	H1.5, H2, H2.5, H3, H4, H5, H6, H8, H10
WP222005	Long arm; H1.5, H2, H2.5, H3, H4, H5, H6, H8, H10

9PC BALL POINT HEX KEY SET (METRIC)

- CR-V steel blade, chrome plated
- Ball point end offers up to a 25° entry angle to get around the obstructions
- Portable plastic rack



Model #	Description
WP222007	Long arm; H1.5, H2, H2.5, H3, H4, H5, H6, H8, H10

Model #	Description
WP222006	H1.5, H2, H2.5, H3, H4, H5, H6, H8, H10

9PC LONG ARM HEX KEY SET WITH T-HANDLE (METRIC)

**STRENGTH
HELPING
T-HANDLE**

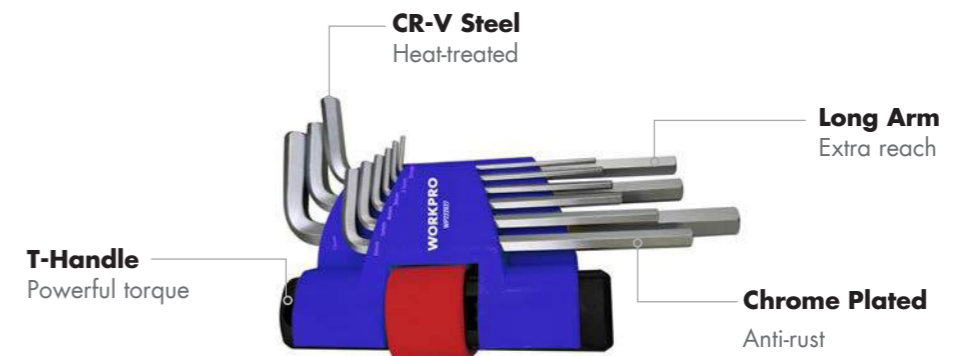

Model #	Description
WP222027	Long arm; 9PC; H2, H2.5, H3, H4, H5, H6, H7, H8, H10

30PC LONG ARM HEX KEY SET (METRIC&SAE)

- Chrome Vanadium steel for long corrosion resistance
- Black finished for rust resistance and long life



Model #	Description
WP222018	15PC SAE H0.028", H0.035", H0.050", H1/16", H5/64", H3/32", H7/64", H1/8", H9/64", H5/32", H3/16", H7/32", H1/4", H5/16", H3/8"; 15PC metric H0.7, H0.9, H1.3, H1.5, H2.0, H2.5, H3.0, H4.0, H4.5, H5.0, H5.5, H6.0, H7.0, H8.0, H10.0

10PC HEX KEY SET (METRIC)

- CR-V steel blade
- Black finish
- Easy to carry



Model #	Description
WP222001	H1.5, H2, H2.5, H3, H4, H5, H5.5, H6, H8, H10

230MM(9") HEAVY DUTY CAULKING GUN

2-GRADE ADJUST



- 360° Swivel Barrel**
Suitable for use in narrow spaces
- Adjustable Drip-Free Switch**
- 2-Grade Adjust**
- 90mm Seal Puncture Tool**
- Aluminum Alloy Handle**
Lightweight

Model #	Description
WP224001	Max.Capacity 295ml(10oz)

SAUSAGE CAULKING GUN

- Lightweight aluminum barrel
- Thrust ratio 4:1
- High-strength pushing rod for long-lasting use
- 2 PP nozzles and 3 scrapers



Model #	Description
WP224002	230mm(9")
WP224006	375mm(15")

RATCHET ROD CAULKING GUN

- Ratchet rotating construction
- Spout cutter
- Seal puncture tool



Model #	Description
WP224004	230mm(9")

230MM (9") CAULKING GUN

- Drip-free mechanism
- Seal puncture tool
- Wide application



Model #	Description
WP224005	230mm(9")

CAULKING GUN

- Aluminum handle
- Comfortable pistol grip
- Economic and lightweight

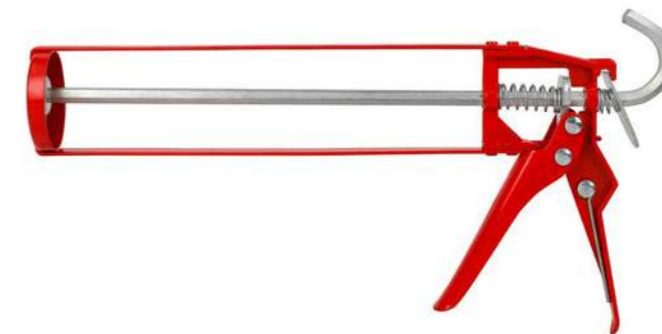

Model #	Description
WP224003	230mm(9")

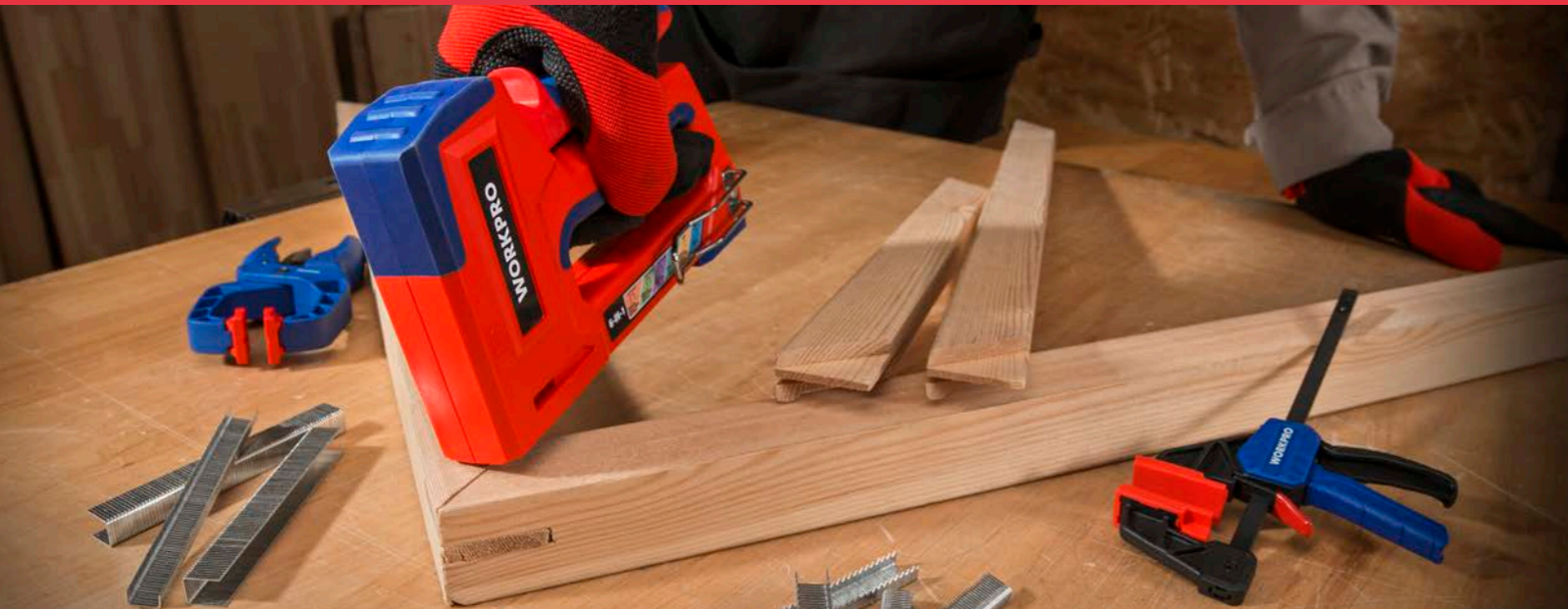

6-IN-1 STAPLE GUN

FUNCTION DUAL POWER



Model #	Description
WP223002	1/4-9/16" ARROW T50/ STANLEY TRA700/ RAPID N140
	1/4-9/16" ARROW JT21/ STANLEY TRA200/ RAPID N53
	1/4-9/16" ARROW T20/ STANLEY CT300
	3/8-9/16" ARROW T25/ STANLEY CT100/ RAPID N36
	1/4-9/16" ARROW BN18/ STANLEY SWKBN/ RAPID N8
	5/8" PIN/ RAPID N9

STAPLE GUN

- Long-lasting chrome-plated finish
- Easy push lockdown handle
- Solid steel mechanism with quick jam release
- Adjustable knob



Model #	Description
WP223004	4-14mm, ARROW T50, STANLEY TRA700, RAPID #140

STAPLE GUN SET

- 3-IN-1
- Adjustable knob



Model #	Description
WP223005	1PC staple gun, 500PC 8 x 1.2 x 11.3 staples, 500PC 12mm U staples, 500PC 14mm nails, 1PC handy storage case

STAPLE GUN

- PC+ABS alloy shell, easy to use
- Equipped with 800PC JT21 8mm staples
- Built-in staple remover



Model #	Description
WP223001	6-10mm(1/4"-3/8") ARROW J21 / RAPID N53

STAPLES

- Q235 material
- 7500PC



Model #	Description
WP223003	2500PC 10mm T50, 2500PC 12mm T50, 2500PC 15mm brad nails

5-IN-1 HEAVY DUTY RIVETER SET



***Notice: 6.4mm stainless steel rivets cannot be used.**

Model #	Description
WP225004	Includes staples: 2.4mm, 3.2mm, 4.0mm, 4.8mm, 6.4mm

5-IN-1 HEAVY DUTY RIVETER SET

- Labor-saving design
- Stepless transmission structure

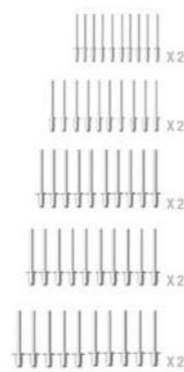

Model #	Description
WP225003	Includes staples: 2.4x6mm(20pc), 3.2x6mm(20pc), 4.0x 6mm(20pc), 4.8x6mm(20pc), 6.4x13mm(20pc)

400MM HAND RIVET GUN

- Extra-long handles provide excellent leverage
- Cr-Mo jaws
- Spent mandrels are collected in the container



Model #	Description
WP225001	Includes 5 nosepieces: 2.4mm(20pc), 3.2mm(20pc), 4.0mm(20pc), 4.8mm(20pc), 6.4mm(20pc)

200MM HAND RIVETER

- Aluminum body
- Self-opening spring
- Cr-Mo jaws



Model #	Description
WP225002	4 rivets sizes: 2.4mm, 3.2mm, 4.0mm, 4.8mm

250MM HAND RIVETER

- Spring loaded handle
- One wrench stored in the handle
- Q235A material



Model #	Description
WP225005	Rivet size: 2.4mm, 3.2mm, 4.0mm, 4.8mm

250MM HAND RIVETER

- Spring loaded handle
- One wrench stored in the handle
- Casting in high-strength aluminum

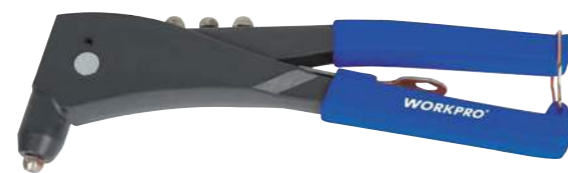

Model #	Description
WP225006	Rivet size: 2.4mm, 3.2mm, 4.0mm, 4.8mm





STRIKING TOOLS

**HAMMER
AXE
UTILITY BAR
CHISEL**

ONE-PIECE CLAW HAMMER

ONE-PIECE DROP FORGED

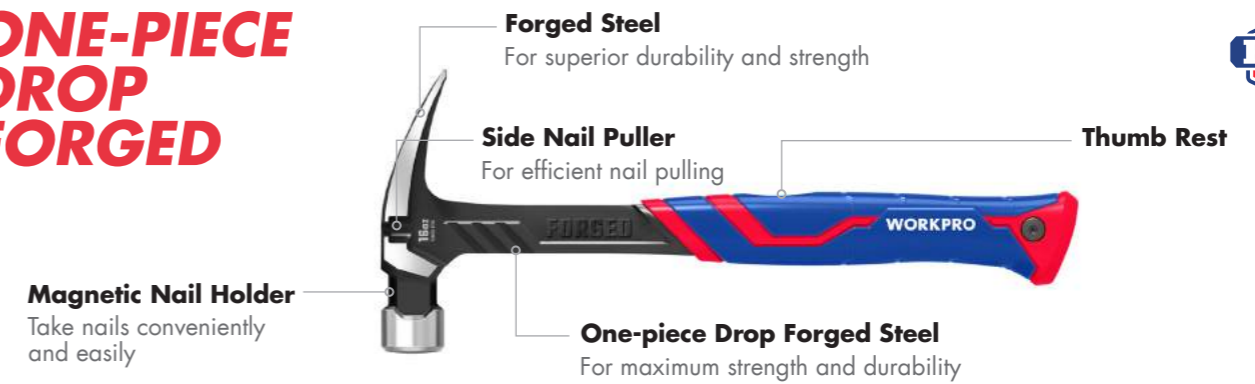

Model #	Description
WP241013	16OZ(450g)

Model #	Description
WP241014	20OZ(560g)

FIBERGLASS CLAW HAMMER

SUPER SELECTED



Model #	Description
WP241009	8OZ(225g)
WP241010	12OZ(337g)

Model #	Description
WP241011	16OZ(450g)
WP241012	20OZ(560g)

FIBERGLASS CLAW HAMMER, BRITISH TYPE

BRITISH TYPE



Model #	Description
WP241044	ϕ 27mm

ONE-PIECE FORGED CLAW HAMMER WITH AIR CUSHION HANDLE

AIR-TECH CONTROL SYSTEM ANTI-SHOCK



Magnetic Nail Holder

Model #	Description
WP241015	20OZ(560g)

STUBBY CLAW HAMMER

- Drop forged carbon steel
- Comfortable handle with rubber grip
- Lanyard hole, easy to storage and carry



Model #	Description
WP241008	8OZ(225g)

CURVED CLAW HAMMER

- Drop forged carbon steel
- Strong hardwood handle construction



Model #	Description
WP241004	8OZ(225g)
WP241005	12OZ(337g)
WP241006	16OZ(450g)
WP241007	20OZ(560g)

CURVED CLAW HAMMER

- Drop forged carbon steel
- Comfortable tubular handle with rubber grip



Model #	Description
WP241001	8OZ(225g)
WP241002	12OZ(337g)
WP241003	16OZ(450g)

WEEKEND HAMMER

- Unique bottle opener included
- Drop-forged heat-treated steel head
- Ideal for party time



Model #	Description
WP241016	8OZ(225g)

FIBERGLASS BALL-PEIN HAMMER

- Great for striking punches, chisels, rivets or forming unshaped metal sheets
- Fiberglass handle, sturdy and durable



Model #	Description
WP241029	16OZ(450g)
WP241030	24OZ(675g)

FIBERGLASS MACHINIST HAMMER

- High-quality carbon steel forged with black polished surface
- Fiberglass handle, sturdy and durable
- Ideal for metal fabrication, chiseling, rivet work



Model #	Description
WP241021	200g
WP241022	300g
WP241023	500g
WP241045	1000g

WOOD BALL-PEIN HAMMER

- Strong hardwood handle construction
- Ideal for use with cold chisels, punches, rivets and for the shaping of metal



Model #	Description
WP241024	8OZ(225g)
WP241025	12OZ(337g)
WP241026	16OZ(450g)
WP241027	24OZ(675g)
WP241028	32OZ(900g)

MACHINIST HAMMER WITH WOOD HANDLE

- Carbon steel forged with black polished surface
- Strong hardwood handle construction
- Ideal for metal fabrication, chiseling, rivet work



Model #	Description
WP241017	200g
WP241018	300g
WP241019	500g
WP241020	1000g

FIBERGLASS STONE HAMMER

- Great for striking punches, chisels, rivets or forming unshaped metal sheets
- Fiberglass handle, sturdy and durable

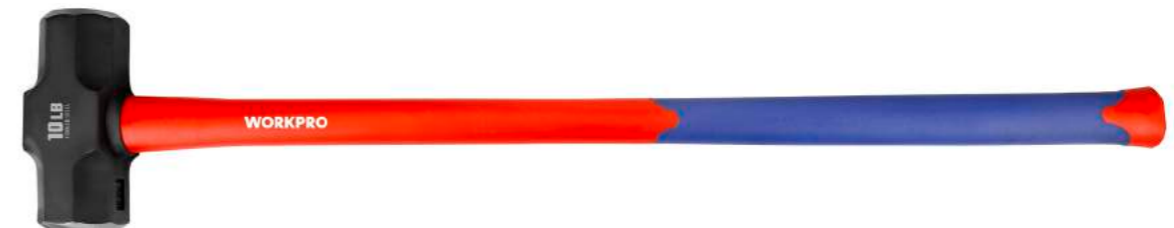

Model #	Description
WP241034	4500g(10LB)

FIBERGLASS STONE HAMMER

- Carbon steel forged with black polished surface
- Fiberglass handle, sturdy and durable



Model #	Description
WP241031	900g (2LB)
WP241032	1350g (3LB)
WP241033	1800g (4LB)

DOUBLE FACE HAMMER

- Detachable dual heads mallet
- Non-slip rubber handle grip, reduces vibration and bounce



Model #	Description
WP241035	φ 35mm

FIBERGLASS DOUBLE FACE HAMMER

- Detachable dual PVC heads mallet
- Fiberglass handle, sturdy and durable



Model #	Description
WP241036	φ 40mm

DEAD BLOW HAMMER

- PVC body
- Non-marring plastic surface
- Non-rebounding & non-spark
- Shot-filled head reduces post-strike rebound
- Suitable for installation of floors, tiles, window repair and more



Model #	Description
WP241037	1.5LB(675g)

RUBBER Mallet WITH WOOD HANDLE

- Solid rubber head
- Comfortable wooden handle
- Non-rebounding, non-spark



Model #	Description
WP241038	Color: white; Length: 300mm
WP241039	Color: black; Length: 300mm

RUBBER Mallet WITH PLASTIC HOLLOW HANDLE

- Plastic handle free of mildew, deformation and cracking
- Lightweight PP hollow handle



Model #	Description
WP241040	Color: white; 16OZ(450g)
WP241041	Color: black; 16OZ(450g)

AXE WITH HICKORY HANDLE

- Higher-strength fraxinus manschurica handle
- With leather protective sleeve



Model #	Description
WP241042	560g(1.25LB)

AXE WITH FIBERGLASS HANDLE

- Carbon steel forged with black polished edge
- High-strength and durable heat-treated
- wide-blade axe



Model #	Description
WP241043	600g



457MM(18") FUBAR UTILITY BAR

- 4-in-1 tool for prying, splitting, board bending and striking jobs
- One-piece forged steel bar for durability
- Board-grabbing jaw sized for 2x lumber
- Beveled nail slot for pulling and prying nails



Model #	Description
WP245006	457mm(18")

INDEXABLE PRY BAR SET

HEADS ROTATE FOR MAX. ACCESS



5-position Locking Head

Push down the button and turn the claw

One-piece Forged Steel

For added strength and durability

Two Beveled Nail Slots

With polished sharp blades for easy insertion



Model #	Description
WP245005	1PC 200mm(8"), 1PC 250mm(10")
WP245007	200mm(8")
WP245008	200mm(10")

UTILITY BAR

- Drop forged carbon steel
- Slim profile for working in awkward areas
- Integrated nail pulling jaws



Model #	Description
WP245001	300mm(12")
WP245002	450mm(18")

WRECKING BAR

- Strong one-piece forged steel construction
- Integrated nail pulling function



Model #	Description
WP245003	600mm(24")
WP245004	900mm(36")

WOOD CHISEL

HEAVY DUTY

- Drop-forged CR-V steel long blade
- Blade edge honed
- Steel butt designed for heavy pounding
- Ergonomic grip handle



Model #	Description
WP243004	6mm(1/4")
WP243005	10mm(3/8")
WP243006	12mm(1/2")
WP243007	16mm(5/8")
WP243008	18mm(3/4")

Model #	Description
WP243009	20mm(13/16")
WP243010	25mm(1")
WP243011	32mm(1-1/4")
WP243012	38mm(1-1/2")

3PC WOOD CHISEL

- 12,20,25mm(1/2", 13/16, 1")
- Drop-forged chrome-vanadium steel blade, heat treated for edge retention
- 30% Longer Blade edge honed
- Steel butt designed for heavy pounding with a hammer or mallet
- HEAVY DUTY Ergonomic grip handle



Model #	Description
WP201301	3PC, 12,20,25mm(1/2", 13/16, 1")

WOOD CHISEL

- Hardened & tempered carbon steel blades
- Steel caps for use with mallet



Model #	Description
WP243001	12mm(1/2")
WP243002	19mm(3/4")
WP243003	25mm(1")

3PC WOOD CHISEL

- High visibility comfort shaped handles
- Hardened & tempered steel blades
- Steel caps for use with mallet
- Includes protective blade guards



Model #	Description
WP201300	3PC, 12,19,25mm(1/2",3/4",1")

CONCRETE CHISEL

- Drop forged CR-V steel blade,
- heat-treated for durability
- Ideal for cutting through and breaking up concrete



Model #	Description
WP242001	Length: 305mm(12"); Blade width: 4mm(5/32")

COLD CHISEL

- Drop forged CR-V steel blade, heat-treated for durability
- Ideal for cutting through and breaking up concrete



Model #	Description
WP242002	Length: 305mm(12"); Blade width: 25mm(1")

3PC COLD CHISEL SET

- Heat-treated, forged premium carbon steel
- Hexagonal body, not easy to deform



Model #	Description
WP201302	1PC 10x8x142mm, 1PC 13x10x152mm, 1PC 16x13x172mm

5PC PUNCH & CHISEL SET

- Heat-treated, forged premium carbon steel
- Hexagonal body, not easy to deform



Model #	Description
WP201303	1PC taper punch 2x10x140mm, 1PC cold chisel 13x10x150mm, 1PC center chisel 6x10x140mm, 1PC pin punch 8x10x150mm, 1PC cape chisel 5x10x150mm

6PC PIN PUNCH SET

- Heat-treated, forged premium carbon steel
- Hexagonal body, not easy to deform



Model #	Description
WP201304	1PC 1.5x6x150mm, 1PC 3x8x150mm, 1PC 4x8x150mm, 1PC 5x8x150mm, 1PC 6x10x150, 1PC 8x10x150mm



CUTTING TOOLS

- KNIFE
- SCISSORS
- SCRAPER
- SAW

ALUMINUM QUICK-CHANGE UTILITY KNIFE

- Quick-change mechanism
- 3-Position switch (-35°/0°/+35°)
- Aluminum body
- Button lock

QUICK FOLDING MECHANISM

MULTI LOCK POSITION

PUSH

Model #	Description
WP211013	185/155x47x22mm

LED QUICK-CHANGE UTILITY KNIFE

LED LIGHT

Quick-change Mechanism

Thumb Rest

Button Lock Structure
Quick opening knife

Light Button

Aluminum Handle

Model #	Description
WP211009	176/121x44x24mm



ALUMINUM RETRACTABLE UTILITY KNIFE

4
POSITIONS

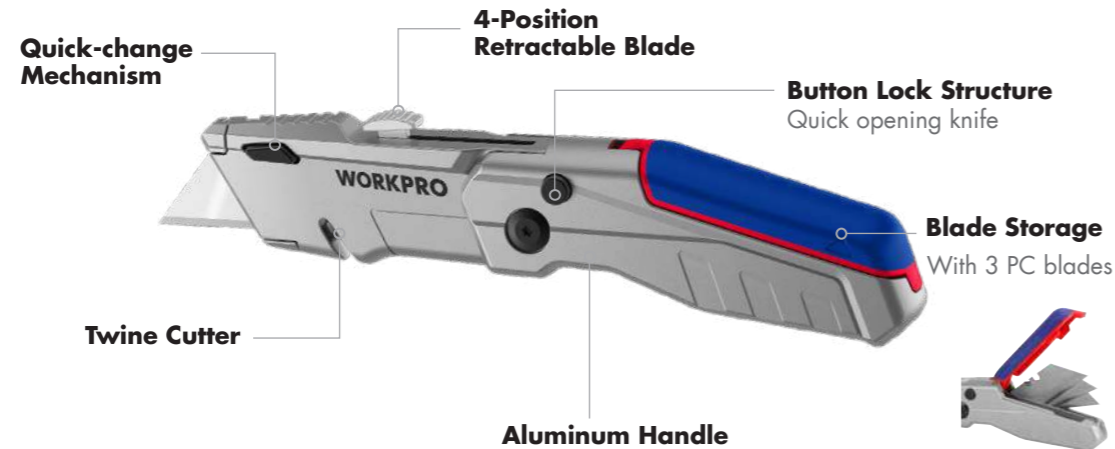

Model #	Description
WP211011	170/105x40x28mm

NYLON HANDLE QUICK-CHANGE UTILITY KNIFE

SPEED
RELEASE



Model #	Description
WP211008	Blue
WP211017	Black
WP211018	Red

MINI ALUMINUM QUICK-CHANGE UTILITY KNIFE

- Quick-change mechanism
- All-metal body
- Folding back lock
- Belt clip



Model #	Description
WP211010	105/67x19x11mm

ALUMINUM QUICK-CHANGE UTILITY KNIFE

- Quick-change mechanism
- All-metal body
- Folding back lock
- Belt clip



Model #	Description
WP211005	140/90x42x34mm

STAINLESS STEEL QUICK-CHANGE UTILITY KNIFE

- Quick-change mechanism
- Stainless steel body
- Folding liner lock



Model #	Description
WP211007	165/100x42x34mm

ALUMINUM QUICK-CHANGE UTILITY KNIFE

- Aluminum handle with comfort grip
- Folding liner lock, twine cutter
- 10PC blades included
- Quick-change mechanism



Model #	Description
WP211012	175mm

BI-MATERIAL QUICK-CHANGE UTILITY KNIFE

- Quick-change mechanism
- ABS handle
- Folding back lock
- Blade storage
- Thumb rest



Model #	Description
WP211006	165/100x42x34mm

WOODEN QUICK-CHANGE UTILITY KNIFE

- Back lock structure
- Stainless steel and wooden handle
- Quick-change mechanism
- With 10PC blades in box



Model #	Description
WP211014	165/105x40x22mm

STAINLESS STEEL QUICK-CHANGE UTILITY KNIFE

- Quick-change mechanism
- Stainless steel body
- Folding liner lock
- Belt clip



Model #	Description
WP211001	135/75x20x6mm

ALUMINUM QUICK-CHANGE UTILITY KNIFE

- Quick-change mechanism
- Aluminum handle
- Folding liner lock
- Belt clip



Model #	Description
WP211003	155/95x35x17mm

FOLDING UTILITY KNIFE

- Quick-change mechanism
- Metal blade holder
- Folding back lock
- Belt clip



Model #	Description
WP211002	160/100x28x12mm

PLASTIC QUICK-CHANGE UTILITY KNIFE

- Quick-change mechanism
- Folding button lock
- Thumb stud



Model #	Description
WP211004	137/87x38x13mm

DUAL-BLADE FLIP QUICK-CHANGE UTILITY KNIFE

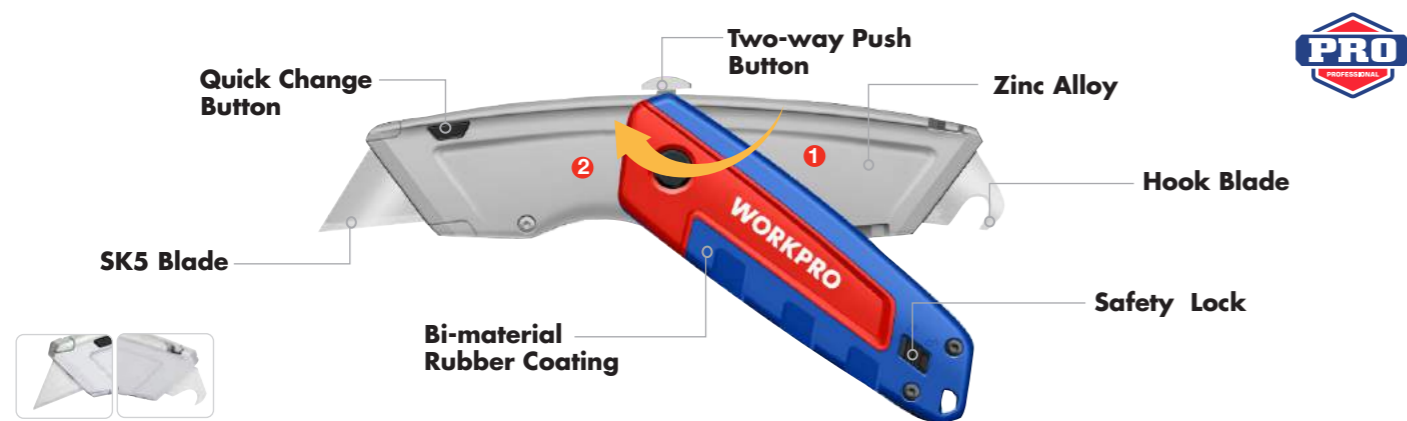

Model #	Description
WP213016	170x35x20mm

AUTO-RETRACTING UTILITY KNIFE

SAFETY SELF-RETRACTING



Model #	Description
WP213010	160x48x43mm

QUICK-CHANGE RETRACTABLE UTILITY KNIFE

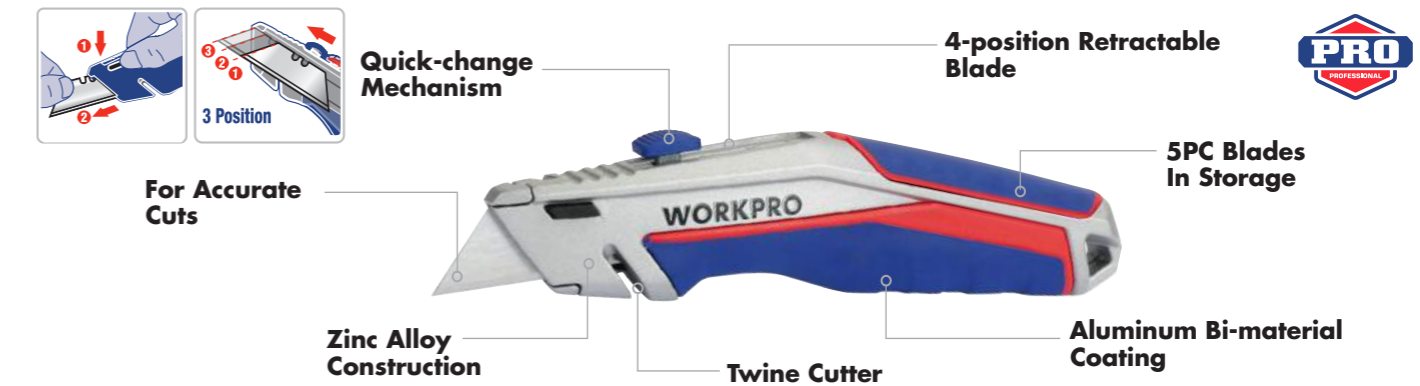

Model #	Description
WP213014	175x40x25mm

HEAVY DUTY FIXED BLADE UTILITY KNIFE

- Zinc alloy bi-material rubber coating
- Safe retractable blade
- Blade locked in 4-position
- With 5PC blades in storage



Model #	Description
WP213013	160x50x22mm

QUICK-CHANGE RETRACTABLE UTILITY KNIFE

- Zinc alloy with bi-material rubber coating
- 3-position retractable blade
- Quick-change mechanism
- With rope cutting notch
- With 5PC blades in storage



Model #	Description
WP213015	180x40x25mm

ALUMINUM RETRACTABLE UTILITY KNIFE

- Aluminum alloy case
- Safe retractable blade
- Blade locked in 3-position
- Thumb position design
- With 1PC blade in storage



Model #	Description
WP213006	160x37x21mm

AUTO-RETRACTING SAFETY KNIFE

- Aluminum alloy case
- Safe automatic retractable blade
- Thumb position design
- With large knob, more convenient
- With 1PC blade in storage



Model #	Description
WP213007	152x35x23mm

ALUMINUM QUICK-CHANGE UTILITY KNIFE

BUILT-IN ROPE CUTTER



Model #	Description
WP213008	Black
WP213017	Red
WP213019	Blue

ALUMINUM QUICK-CHANGE UTILITY KNIFE



Model #	Description
WP213009	Red

Model #	Description
WP213020	Blue

QUICK OPEN UTILITY KNIFE

- Aluminum bi-material rubber coating
- Safe retractable blade
- Blade locked in 4-position
- Quick opening mechanism
- With 3PC blades in storage



Model #	Description
WP213011	165x41x28mm

ALUMINUM RETRACTABLE UTILITY KNIFE

- Aluminum alloy case
- Safe retractable blade
- Blade locked in 3-position
- 3PC blades in storage
- Suitable for all standard blades



Model #	Description
WP213005	150x35x20mm

AUTO-LOAD RETRACTABLE UTILITY KNIFE

- Aluminum bi-material rubber coating
- Safe retractable blade
- Blade locked in 4-position
- Quick-change & quick-open
- With 5PC blade (1+4)

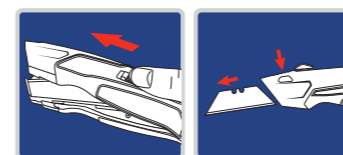

Model #	Description
WP213012	175x42x25mm

AUTO-LOAD SNAP-OFF KNIFE

AUTO-RELOAD BLADE SYSTEM

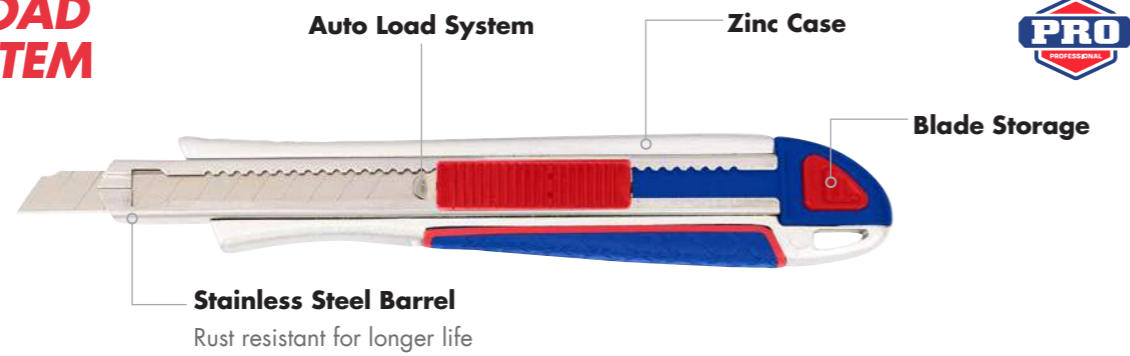

Model #	Description
WP212016	9mm; 13-section

Model #	Description
WP212017	18mm; 8-section

BI-MATERIAL SNAP-OFF KNIFE

FASTER BLADE ADJUSTMENT



Model #	Description
WP212008	9mm; 13-section
WP212009	18mm; 8-section

AUTO-LOAD SNAP-OFF KNIFE

- Positive blade auto-lock
- Comfortable bi-material rubber coating
- Auto load blade mechanism



Model #	Description
WP212010	9mm; 13-section
WP212011	18mm; 8-section

18MM HEAVY DUTY SNAP-OFF KNIFE

HEAVY DUTY



Model #	Description
WP212015	18mm; SK5

9MM ALUMINUM SNAP-OFF KNIFE

- Durable oxidized aluminum handle
- Suitable for standard 9mm snap-off blade
- 8-section 30° blade



Model #	Description
WP212012	Blue, 145x16x12mm
WP212020	Red, 145x16x12mm

PLASTIC SNAP-OFF KNIFE

- Cold-rolled cartridge
- Suitable for standard snap-off blade



Model #	Description
WP212006	9mm; 13-section
WP212007	18mm; 8-section

18MM SNAP-OFF KNIFE

- Durable high-strength plastic case
- Suitable for standard 18mm snap-off blade
- 8-section blade



Model #	Description
WP212013	170x40x20mm

9MM STAINLESS STEEL SNAP-OFF KNIFE

- Durable stainless steel case
- Suitable for standard 9mm snap-off blade
- 13-section blade



Model #	Description
WP212005	140X10mm

10PC SK5 UTILITY KNIFE BLADES WITH HEAVY DUTY BOX

SAFETY AND CONVENIENT

SK5 Blades

Heat-treated, more durable

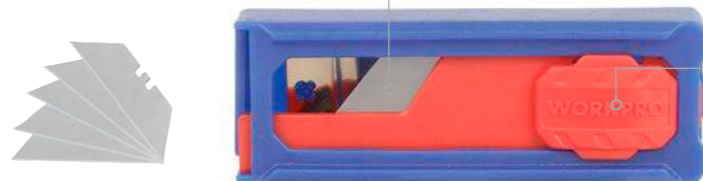

Push Button

1PC blade comes out each time

Model #	Description
WP213002	75x26x17mm

SK2 STEEL UTILITY KNIFE BLADES

TWO DISPENSERS: 1 BLADE OR 5 BLADES

SK2 Blades

Heat-treated, more durable

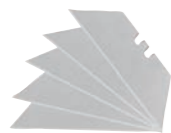

Push Button

1PC/5PC blades come out each time

Model #	Description
WP213004	128x73x33mm

SK5 UTILITY KNIFE BLADES

- More durable heat-treated SK5 blades
- Adapt to general folding/practical knives
- 100 PC standard blade
- Suitable for cardboard/gypsum board/thin board, etc.



SK5 UTILITY KNIFE BLADES

- Suitable for cardboard/gypsum board/thin board, etc.
- 10PC SK5 blade
- One blade comes out each time



Model #	Description
WP213003	124x75x28mm

Model #	Description
WP213001	65x25x13mm

SK2 SNAP-OFF BLADES

- Suitable for cardboard/thin plates, etc.
- 10PC SK2 blades for more durable



Model #	Description
WP212004	10PC; 18mm

SK5 SNAP-OFF BLADES

- Suitable for cardboard/thin plates, etc.
- 10PC SK5 blades



Model #	Description
WP212001	10PC; 9mm
WP212002	10PC; 18mm

14PC HOBBY KNIFE SET

- SK5 blade
- Bi-material rubber-coated handle
- Plastic box for safe storage



Model #	Description
WP219005	Includes 13 pc blades: 3pc #12, 5pc #11, 3pc #3, 2pc #4

MINI SCRAPER

- Great for scraping in hard-to-reach places
- Lightweight and economical plastic razor blade scraper
- Use standard, single-edge razor blade



Model #	Description
WP219001	53x42x7mm

GLASS & TILE SCRAPER

- Quick-change blade function, with 6pcs blades
- Adapt to standard 89mm window scraper blade



Model #	Description
WP219002	182x89x25mm

SCRAPER

- Great for scraping in hard-to-reach places
- Lightweight plastic razor blade scraper
- Use standard, single-edge razor blade



Model #	Description
WP219003	152x35x23mm

4-POSITION RETRACTABLE SCRAPER

- Retractable blade with 4 positions
- Ergonomic handle



Model #	Description
WP219004	160x37x21mm

250MM(10") MULTI-FUNCTION KITCHEN SCISSORS

MULTIFUNCTION FOR KITCHEN USE



Model #	Description
WP214006	255x106mm

200MM(8") MULTI-FUNCTION FORGED SHEARS

MULTI-PURPOSE



Model #	Description
WP214009	200mm(8")

MULTI-FUNCTION SCISSORS

- Comfortable bi-material rubberized handle
- Stainless steel blades
- Wire stripper design
- Anti-slip serrated cutting edge



Model #	Description
WP214008	170x35x20mm

STATIONERY SCISSORS

- Stainless steel blades
- Bi-material comfort-grip handle



Model #	Description
WP214002	140x65mm

185MM(7.5") UNIVERSAL SCISSORS

SUPER SELECTED

Heavy Duty



All-metal Body



Model #	Description
WP214022	185mm(7.5")

200MM(8") SCISSORS

- Stainless steel blades
- Comfort-grip handle



Model #	Description
WP214001	200mm(8")

CLASSIC SCISSORS

- Stainless steel blades
- Bi-material comfort-grip handle



Model #	Description
WP214003	215x80mm

MULTI-FUNCTION KITCHEN SCISSORS

- Stainless steel blades
- Perfect for any task
- The handle is molded to your hand for extra comfort



Model #	Description
WP214005	140/90x42x34mm

4PC SCISSORS SET

- Stainless steel blades
- Multi-purpose cutting
- The handle is molded to your hand for extra comfort



Model #	Description
WP200002	2pc WP214001-1, 1 pc WP214002-1, 1pc WP214005-1

AVIATION TIN SNIP

CR-MO STEEL FORGED BLADE



Also available:
Right cut

Left cut

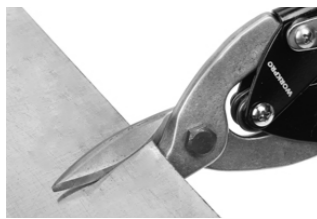

Model #	Description
WP214019	Right cut; 250mm(10")
WP214020	Left cut; 250mm(10")
WP214021	Straight cut; 250mm(10")

RIGHT CUT AVIATION TIN SNIP

- Directional handle design
- Drop forged steel
- Serrated cutting edges prevent materials from slipping during use



Model #	Description
WP214015	250mm(10")

LEFT CUT AVIATION TIN SNIP

- Directional handle design
- Drop forged steel
- Serrated cutting edges prevent materials from slipping during use



Model #	Description
WP214016	250mm(10")

STRAIGHT AVIATION TIN SNIP

- Drop forged steel
- Serrated cutting edges
- Ergonomic comfort grip handle



Model #	Description
WP214017	250mm(10")

Model #	Description
WP214018	300mm(12")

3PC 250MM(10") AVIATION SNIP SET

- Drop forged steel
- Serrated cutting edges prevent materials from slipping during use
- Ergonomic comfort grip handle



Model #	Description
WP200001	250mm(10")

STRAIGHT TIN SNIP

- Drop forged steel
- Precision ground blades
- Large handle loops
- Dipped grip handle



Model #	Description
WP214011	180mm(7")
WP214012	250mm(10")
WP214013	300mm(12")

STRAIGHT TIN SNIP

- Drop forged steel
- Precision ground blades
- Dipped grip handle



Model #	Description
WP214014	255x50x24mm

BOLT CUTTER

CR-MO FORGED BLADE

CR-MO
STEEL BLADE



Cr-Mo Steel Blade

Double Levers
Labor-saving

Tri-color Handle
Anti-slip



Model #	Description
WP216002	300mm(12"); Cut max.φ5mm steel bars
WP216003	350mm(14"); Cut max.φ7mm steel bars
WP216004	450mm(18"); Cut max.φ8mm steel bars
WP216005	600mm(24"); Cut max.φ11mm steel bars
WP216006	750mm(30"); Cut max.φ13mm steel bars
WP216007	900mm(36"); Cut max.φ16mm steel bars

BOLT CUTTER

CR-MO
STEEL BLADE

- Cr-Mo steel blade
- Labor-saving double levers
- Anti-slip bi-color handle



Model #	Description
WP216008	1050mm(42"); Cut max.φ19mm steel bars

200MM(8") BOLT CUTTER

- 65Mn steel jaws
- Jaws hardened to HRC 56-60 for longer life
- Two-color soft rubber coating for comfortable grip
- Ergonomic design
- Shear 3.5mm steel bar



Model #	Description
WP216001	200mm(8"); Cut max.φ3.5mm steel bars

600MM(24") FOLDING BOLT CUTTER

FOLDING DESIGN FOR COMPACT STORAGE

600
mm
24 INCH



60CR-V Steel Blade

Double Levers
Labor-saving



Foldable Handle



Model #	Description
WP216009	600mm(24"); Cut max.φ11mm steel bars



SK5 HAND SAW

SHARPER TRIGROUND TEETH



Model #	Description
WP215005	400mm(16"); 7TPI
WP215006	450mm(18"); 7TPI
WP215007	500mm(20"); 7TPI
WP215008	550mm(22"); 7TPI

Model #	Description
WP215009	600mm(24"); 7TPI
WP215010	450mm(18"); 11TPI
WP215011	500mm(20"); 11TPI
WP215012	550mm(22"); 11TPI

SK5 HAND SAW

SHARPER THREE-EDGED TEETH



- Durable SK5 saw blade
- Teflon surface treatment for smoother use
- Sharper three-edge precision grinding teeth
- Large and small tooth design
- With scale mark



TEFLON

Model #	Description
WP215013	400mm(16"); 8TPI

HAND SAW

- 65Mn saw blade with precision ground teeth
- Ergonomic handle
- With scale mark



65Mn Saw Blade
With precision ground teeth

Model #	Description
WP215001	400mm(16"); 7TPI
WP215002	450mm(18"); 7TPI

Model #	Description
WP215003	500mm(20"); 7TPI
WP215004	550mm(22"); 7TPI

BACK SAW

- 65Mn saw blade, more durable
- Sharp two-edged grinding teeth
- Can be used with mitre box (WP215029)



Model #	Description
WP215014	300mm(12"); 12TPI

Model #	Description
WP215015	350mm(14"); 12TPI

JAB SAW

INDUCTION HARDENED BLADE



Sharp Point Design
Quickly drilling holes



65Mn Saw Blade
With precision ground teeth

Tri-color Handle
Ergonomic design

Model #	Description
WP215016	150mm(6"); 7TPI

BI-METAL JAB SAW

BI-METAL FOR LONG-LASTING



Sharp Point Design
Quickly drilling holes



Teflon Coated Blade
More durable

Triple-edge Ground Teeth
For faster cutting

Tri-color Handle
Ergonomic design

Model #	Description
WP215017	150mm(6"); 8TPI

300MM(12") COMPASS SAW



65Mn Saw Blade
With precision ground teeth



Tri-color Handle
Ergonomic design

Model #	Description
WP215018	300mm(12"); 7TPI

300MM(12") ALUMINUM HACKSAW

HEAVY-DUTY AND STRONG



Aluminum Alloy Frame
Heavy-duty and durable



Tri-color Handle
Comfortable and anti-slip

Adjustable Knob
High tension

Bi-metal Blade

Model #	Description
WP215027	300mm(12"); 24TPI

300MM(12") HEAVY DUTY HACKSAW



Heavy-duty Tubular Frame
For strength and durability

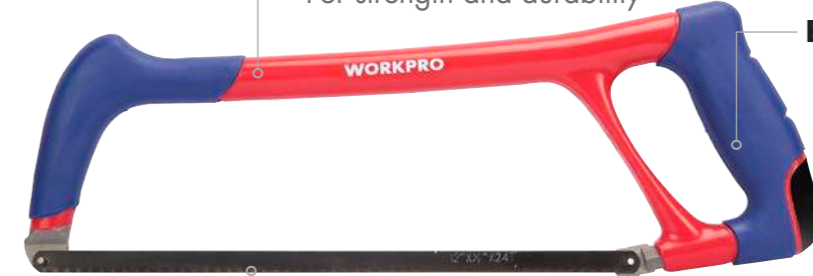

Ergonomic Soft Grip

Bi-metal Blade

Model #	Description
WP215025	300mm(12"); 24TPI

HEAVY DUTY HACKSAW

- Aluminum alloy frame
- 2-position: 90° and 45°
- Quick-release, blade changing mechanism
- 1PC bi-metal blade



Model #	Description
WP215022	300mm(12")

3-LENGTH HACKSAW

- Adjustable length
- Ergonomic grip design
- Quick-release, blade changing mechanism



Model #	Description
WP215020	Adjustable to 200mm(8"), 250mm(10"), 300mm(12")

ALUMINUM HACKSAW

- Aluminum alloy frame
- Adjustable tension
- Quick-release, blade changing mechanism



Model #	Description
WP215026	300mm(12")

ALUMINUM JUNIOR HACKSAW

- Comfortable handle
- Aluminum alloy frame
- Adjustable for 3 directions
- Easy turning knob for removing & inserting blades



Model #	Description
WP215021	150mm(6"); Cutting depth: 63mm

ALUMINUM MINI HACKSAW

- Aluminum alloy frame
- Ergonomic rubber handle
- 1PC bi-metal blade



Model #	Description
WP215023	250mm(10"); 24TPI

TUBULAR BOW SAW

- Made of steel tubing for durability and easy handling
- Soft grip for heavy duty use
- Easy to change blade
- Safety handle



Model #	Description
WP215019	530mm(21")

300MM(12") MITRE BOX

- 2 countersunk slots on the base for fixing to bench
- Durable plastic body
- 45°, 90°, and 135° fixed cutting angles

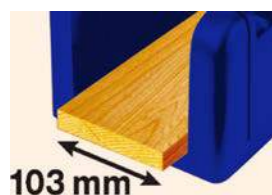

Model #	Description
WP215029	300mm(12")

10PC CARBON STEEL SAW BLADE SET (24TPI)

- Heavy-duty tubular frame
- Ergonomic soft grip handle
- High tension blade
- Bi-metal blade



Model #	Description
WP215031	10PC; 300mm(12"); 24TPI

5PC BI-METAL SAW BLADE SET

- Double saw blade, more durable
- Ultra-high-frequency treatment of teeth
- Compatible with the standard 300mm saw frame



Model #	Description
WP215032	5PC; 300mm(12"); 18TPI
WP215033	5PC; 300mm(12"); 24TPI

10PC MINI SAW BLADE SET (24TPI)

- Selected high-quality steel
- Suitable for standard 150mm saw frame



Model #	Description
WP215034	10PC; 150mm(6"); 24TPI



FINISHING TOOLS

FILE
BRUSH
BLOCK PLANE
SANDPAPER

FLAT FILE

ERGONOMIC HANDLE



Heat-treated T12
More wear-resistant

Tri-color Handle
Anti-slip



Hanging Hole

Model #	Description
WP251001	200mm(8")
WP251002	250mm(10")

HALF ROUND FILE

- Heat-treated T12 material
- Tri-color handle
- With hanging hole



Model #	Description
WP251003	200mm(8")
WP251004	250mm(10")

ROUND FILE

- Heat-treated T12 material
- Tri-color handle
- With hanging hole



Model #	Description
WP251005	200mm(8")
WP251006	250mm(10")

TRIANGULAR FILE

- Heat-treated T12 material
- Tri-color handle
- With hanging hole



Model #	Description
WP251007	200mm(8")
WP251008	250mm(10")

SQUARE FILE

- Heat-treated T12 material
- Tri-color handle
- With hanging hole



Model #	Description
WP251009	200mm(8")
WP251010	250mm(10")

FLAT WOOD RASP FILE

- Heat-treated 45# steel
- Tri-color handle
- With hanging hole



Model #	Description
WP251011	200mm(8")
WP251012	250mm(10")

ROUND WOOD RASP FILE

- Heat-treated 45# steel
- Tri-color handle
- With hanging hole



Model #	Description
WP251013	200mm(8")
WP251014	250mm(10")

HALF ROUND WOOD RASP FILE

- Heat-treated 45# steel
- Tri-color handle
- With hanging hole



Model #	Description
WP251015	200mm(8")
WP251016	250mm(10")

3PC FILE SET

- Wear-resistant T12 material
- Ergonomic handle
- With hanging hole



Model #	Description
WP201702	3PC; 200mm(8")

5PC FILE SET

- Wear-resistant T12 material
- Ergonomic handle
- With hanging hole



Model #	Description
WP201701	5PC; 200mm(8")

3PC WOOD RASP FILE SET

- Heat-treated 45# steel
- Anti-slip tri-color handle
- With hanging hole



Model #	Description
WP201703	3PC; 200mm(8")

5PC INTERCHANGEABLE FILE SET

- Durable heat-treated steel
- Ergonomic interchangeable handle
- Equipped with wooden files and steel files

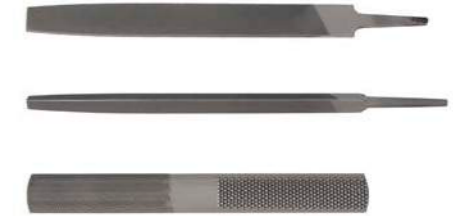

Model #	Description
WP251017	5PC; 200mm(8")

6PC MINI FILE SET

- Durable heat-treated steel
- Ergonomic interchangeable handle



Model #	Description
WP251018	6PC; 3x140mm

5PC DIAMOND NEEDLE FILE SET

- Fine diamond grit
- Dipped grip handle



Model #	Description
WP251019	5PC; 3x140mm; 150 grit

10PC DIAMOND NEEDLE FILE SET

- Diamond particle surface
- Compact small size
- Easy-to-clean handle



Model #	Description
WP251020	10PC; 3x140mm



STEEL WIRE BRUSH, 3X17

DUAL FUNCTION WITH SCRAPER



Steel Bristles
Black finish for durable and anti-corrosion



Model #	Description
WP253001	3x17

STEEL WIRE BRUSH, 4X16

- Black finished steel wire
- Easy-to-clean plastic handle



Model #	Description
WP253002	4x16

COPPER-COATED WIRE BRUSH

- Copper-coated steel wire
- Durable metal brush



Model #	Description
WP253003	Length:250mm

COPPER-COATED WIRE BRUSH WITH WOODEN HANDLE

- Copper-coated steel brush wire
- Classic wooden body



Model #	Description
WP253004	4X15

3PC WIRE BRUSH SET

- Coming with stainless steel/copper/nylon brush wire
- With brush wire on the head
- Bi-material rubber coating handle



Model #	Description
WP253005	3PC; Length:180mm

230MM(9") ADJUSTABLE BENCH PLANE

PRECISION MILLED BASE AND FACES



Model #	Description
WP252001	230mm(9"); Width of the blade: 50mm

250MM (10") RASP PLANE

- Aluminum alloy body
- Durable T10 blade
- Suitable for gypsum board and wooden

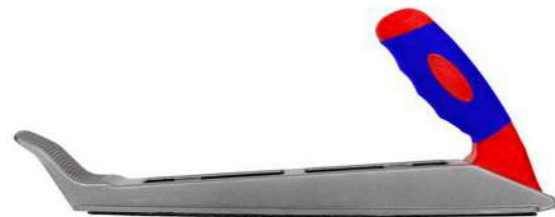

Model #	Description
WP252002	300x42x115mm

3PC ALUMINUM OXIDE SANDING SPONGE

- Double filing surface
- Used in both water and dry grinding



Model #	Description
WP259020	60x100 Grits, 120x180 Grits, 220x280 Grits

150MM DOUBLE-SIDED SHARPENING STONE

- Double-sided whetstone
- Suitable for sharpening and trimming of blade



Model #	Description
WP259021	180x280 Grits

ALUMINUM OXIDE SANDPAPER

- Tough backing paper
- Durable alumina particles
- Dry only



Model #	Description
WP259001	60 Grits; 280x230mm
WP259002	80 Grits; 280x230mm
WP259003	120 Grits; 280x230mm
WP259004	150 Grits; 280x230mm
WP259005	180 Grits; 280x230mm
WP259006	240 Grits; 280x230mm
WP259007	320 Grits; 280x230mm
WP259008	400 Grits; 280x230mm

SANDING BLOCK

- Impact-resistant plastic body
- Stable double-sided clips
- Used with sandpaper



Model #	Description
WP259018	165x85mm
WP259019	210x105mm

SILICON CARBIDE SANDPAPER

- Tough backing paper
- Durable silicon carbide particles
- Dry & wet application



Model #	Description
WP259009	60 Grits; 280x230mm
WP259010	80 Grits; 280x230mm
WP259011	120 Grits; 280x230mm
WP259012	150 Grits; 280x230mm
WP259013	180 Grits; 280x230mm
WP259014	240 Grits; 280x230mm
WP259015	320 Grits; 280x230mm
WP259016	360 Grits; 280x230mm
WP259017	400 Grits; 280x230mm





MEASURING TOOLS

- TAPE MEASURE
- LASER DISTANCE MEASURE
- SPIRIT LEVEL
- RULER
- CALIPER

TAPE MEASURE WITH NYLON COATED BLADE

TOUGH AND DURABLE

Bi-material Rubber Coating
Comfortable and durable



Thumb Lock

Metric & Imperial Scales
Easy to read

Nylon Coated Blade
More durable

Bottom Lock



Model #	Description
WP261008	3m(10ft)x16mm
WP261009	5m(16ft)x19mm
WP261010	7.5m(25ft)x25mm

CHROME TAPE MEASURE

Chrome-plated Case
Impact-resistant



Metric & Imperial Scales
Easy to read

Extra-wide Blade
Nylon coating



Model #	Description
WP261012	8m(26ft)x25mm
WP261013	10m(33ft)x25mm

10M CHROME TAPE MEASURE

- Ergonomic design
- Chrome case
- Belt clip
- Nylon coated blade



Model #	Description
WP261014	5m(16ft)x19mm

TAPE MEASURE



Model #	Description
WP261002	3m x 16mm
WP261003	5m x 19mm
WP261004	7.5m x 25mm

SELF-LOCK TAPE MEASURE

- Self-locking structure
- Durable heat-treated spring
- Metric and imperial scales
- Bi-material rubber coating



Model #	Description
WP261005	3m(10ft) x 16mm
WP261006	5m(16ft) x 19mm
WP261007	7.5m(25ft) x 25mm

3M(10FT) SOFT TAPE MEASURE

- Impact-resistant case
- Metric and Inch scales
- Self-locking design



Model #	Description
WP261001	3m(10ft)

FIBERGLASS MEASURING TAPE

- Fiberglass blade
- Durable ABS case for shock-resistant
- Folding handle for quick rewind tape



Model #	Description
WP263001	30m
WP263002	50m

OPEN REEL FIBERGLASS LONG TAPE RULER

- Fiberglass blade
- Ergonomic comfort grip
- Compact rewind handle



Model #	Description
WP263003	30m
WP263004	50m
WP263005	100m



40M(135FT) RECHARGEABLE LASER DISTANCE MEASURE

SUPER MINI



Model #	Description
WP267001	40m(135ft)



HEAVY DUTY ALUMINUM BOX LEVEL WITH MAGNETIC BASE

WITH MAGNET AND HIGH PRECISION



Model #	Description
WP262019	400mm(16")
WP262020	600mm(24")
WP262021	900mm(36")
WP262022	1200mm(48")
WP262023	1800mm(72")

HEAVY DUTY ALUMINUM BOX LEVEL

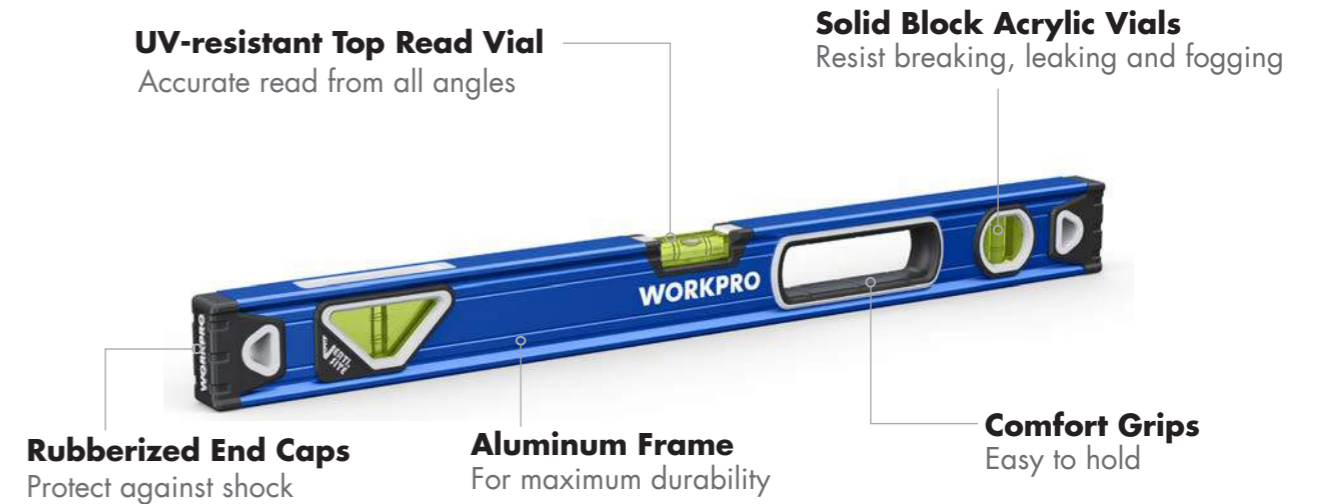

Model #	Description
WP262016	600mm(24")
WP262017	1200mm(48")
WP262018	1800mm(72")

ALUMINUM MAGNETIC BOX LEVEL

- Shockproof end cap
- Aluminum alloy frame
- Big grip ring, convenient to use
- Accuracy 1.0mm/1000mm, 3 vials (45°/90°/180°)
- With scales, easier to read
- Magnetic base



Model #	Description
WP262014	600mm(24")

ALUMINUM MAGNETIC BOX LEVEL

- Shockproof end cap
- Aluminum alloy frame
- Accuracy 0.5mm/1000mm, 3 vials (45°/90°/180°)
- Magnetic base

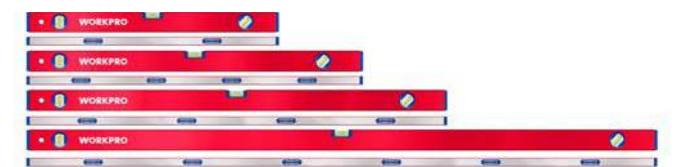

Model #	Description
WP262010	400mm(16")
WP262011	600mm(24")
WP262012	800mm(32")
WP262013	1000mm(40")



ALUMINUM BOX LEVEL

- Aluminum alloy frame
- Shock-resistant cap
- Accuracy 1.0mm/1000mm
- Easy-to-read scale



Model #	Description
WP262001	300mm(12")
WP262002	450mm(18")
WP262003	600mm(24")
WP262004	800mm(32")
WP262005	1000mm(40")
WP262006	1200mm(48")
WP262007	1500mm(60"); Accuracy 1.5‰
WP262008	1800mm(72"); Accuracy 1.5‰
WP262009	2000mm(80"); Accuracy 1.5‰

HEAVY DUTY DIE-CAST ALUMINUM LEVEL

- Accuracy: 1mm/1000mm
- Aluminum body with powder coating



Model #	Description
WP262024	600mm(24")

TORPEDO LEVEL

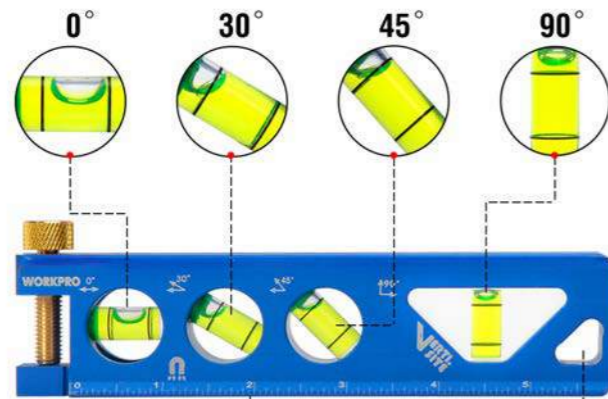

Model #	Description
WP262025	165mm(6.5")

MAGNETIC TORPEDO LEVEL

- Acrylic vials read plumb, level, 45°
- Top read window for convenience
- V-groove working edge fits on pipe or conduit
- Highly visible vials with magnetic base



Model #	Description
WP262026	225mm

MAGNETIC TORPEDO LEVEL

- Magnetic v-groove base
- Visible vials read plumb, level, 45°
- Top read window for convenience
- Aluminum frame
- Rubber end caps for shock-resistant



Model #	Description
WP262027	225mm

FRAME LEVEL

- Special angle design for picture hanging
- Durable acrylic vials 45°
- Top read window for convenience
- Highly visible vials

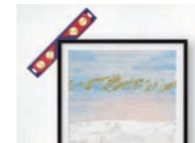

Model #	Description
WP262028	225mm

MAGNETIC POST LEVEL

- Impact-resistant case
- 3 vials (90°/180°)
- Magnetic strip on the back
- Suitable for vertical and cylindrical measurements
- Accuracy 1mm/1000mm



Model #	Description
WP262029	125x75mm

2PC BUBBLE LINE LEVEL

- Mini level, made of ABS material
- With a hook, convenient to storage



Model #	Description
WP262031	Length: 75mm

300MM(12") ALUMINUM COMBINATION SQUARE

- Precision machined die-cast aluminum stock
- Removable brass scribe
- Impact-resistant acrylic vial
- Etched stainless steel blade
- 1/8", 1/16", 1/32" and mm graduations

MM
SAE

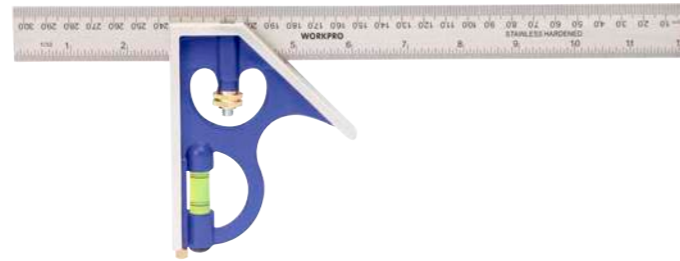

Model #	Description
WP264002	300mm(12")

300MM(12") PLASTIC COMBINATION SQUARE

- Removable brass scribe
- Impact-resistant acrylic vial
- Etched stainless steel blade
- 1/8", 1/16", 1/32" and mm graduations

MM
SAE



Model #	Description
WP264001	300mm(12")

200MM(8") TRY SQUARE

- Brass bound hardwood handle
- 1/8", 1/16" graduations

MM
SAE



Model #	Description
WP264001	300mm(12")

200MM(8") SLIDING T-BEVEL

- High-impact plastic handle with 4-way view vial
- Stainless steel blade
- Cylinder level vial



Model #	Description
WP264005	200mm(8")

SLIDING T-BEVEL WITH WOODEN HANDLE

- Hardwood handle
- Etched stainless steel blade
- 1/8", 1/16", 1/32" and mm graduations

MM
SAE



Model #	Description
WP264006	230mm(9")

ALUMINUM SQUARE LAYOUT TOOL

- Precision machined die-cast aluminum body
- Etched SAE & metric marking

SAE



Model #	Description
WP264007	180mm(7")

STEEL CARPENTER SQUARE

- Steel body with powder coating
- SAE & metric markings

MM
SAE



Model #	Description
WP264008	400x600mm
WP264009	200x300mm

STEEL RAFTER SQUARE

- Hardened steel for durability
- Embossed graduations for easy front and backside reading
- Treated with protective finish for rust-resistance

MM
SAE



Model #	Description
WP264010	400x600mm

STAINLESS STEEL RULER

- Stainless steel
- Permanently etched graduation

MM
SAE



Model #	Description
WP265001	300mm(12")
WP265002	600mm(24")
WP265003	1200mm(48")

150MM(6") DIAL CALIPER

MULTIPLE MEASURING CAPABILITIES



MM

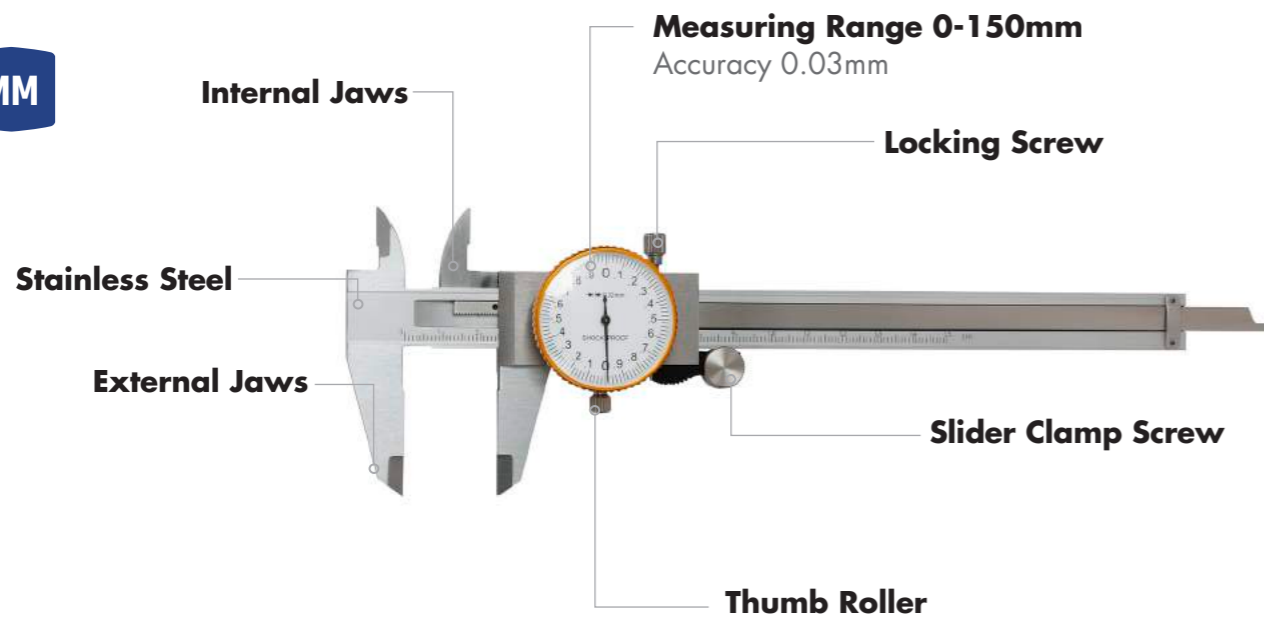

Model #	Description
WP266002	150mm(6")

150MM(6") VERNIER CALIPER

- Stainless steel
- Metric and imperial scale readings
- Accuracy 0.02mm
- Measuring range 0-150mm

MM
SAE



Model #	Description
WP266003	150mm(6")

PLASTIC DIGITAL VERNIER CALIPER

- Lightweight and easy to carry
- The accuracy is $\pm 0.2\text{mm}$
- Metric and imperial readings

MM
SAE



Model #	Description
WP266001	150mm(6")

150MM(6") DIGITAL VERNIER CALIPER

- Zero setting at any position
- Stainless steel body
- LCD display for quick & easy measurement
- Metric/SAE conversion button
- Liner accuracy: 0.02mm/0.001"
- Measuring range: 0-150mm/0-6"
- 2PC LR44 button cell batteries included

MM
SAE



Model #	Description
WP266004	150mm(6")

PLASTIC CONTOUR GAUGE

- Metric and imperial scale measurements
- Easily copy any shape
- ABS plastic, rustproof and durable

MM
SAE



Model #	Description
WP269001	250mm(10")

MULTI ANGLE MEASURING RULER

- Durable oxidation treatment aluminum alloy
- Foldable 6 sections

MM
SAE

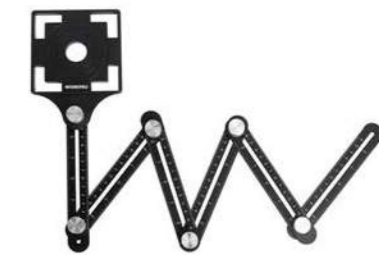

Model #	Description
WP269002	Length: 1400mm

ELECTRICAL TOOLS

WIRE STRIPPER CRIMPING PLIERS CABLE CUTTER
 CABLE STRIPPING KNIFE ELECTRICIAN SCISSORS
 ELECTRICAL TESTER ELECTRICAL TAPE

DIGITAL MULTIMETER

- NCV voltage sensing
- Diode measurement
- On-off buzzer measurement
- Flashlight lighting
- backlight
- Value lock
- Automatic shut-down
- Power supply mode: 2 AAA batteries
- Maximum display 5999



Model	WP295005
DC voltage	0.1mV~600V
AC voltage	1mV~600V
DC current	0.01uA~10A
AC current	0.01uA~10A
Resistance	0.1Ω~60MΩ
Capacitance	1nF~60000uF
Frequency	10Hz~10MHz



DIGITAL CLAMP MULTIMETER

- Ambient temperature measurement
- -20~2000°C
- NCV voltage sensing
- Zero line of fire recognition
- On-off buzzer measurement
- Flashlight lighting
- Value lock
- Automatic shut-down
- Power supply mode: 2 AAA batteries
- Maximum display 5999



Model	WP295006
DC voltage	1mV~1000V
AC voltage	1mV~750V
Resistance	0.1Ω~40MΩ
Frequency	10Hz~10MHz
AC current	0.01A~600A

DIGITAL MULTIMETER

- Ambient temperature measurement 0~40°C
- NCV voltage sensing
- Zero line of fire recognition
- On-off buzzer measurement
- Flashlight lighting
- Value lock
- Automatic shut-down
- Analog bar display
- Power supply mode: 1 AAA battery
- Maximum display 5999



Model	WP295007
DC voltage	0.9V~600V
AC voltage	0.9V~600V
Resistance	10Ω~60MΩ
Frequency	40Hz~999Hz

VOLTAGE TESTER

- Bi-color indicator light
- Sound and light screen triple alarmed mode
- With LED lighting function
- With pen clip design, easy to carry
- Automatic induction, sensitive induction



Model #	WP295004
Measuring range	AC12V-1000V



AUTOMOTIVE VOLTAGE TESTER

- Measuring range: 6-24V
- Insulated Alligator Clip
- Transparent plastic handle, red and green dual-color LED light display
- Stainless steel tip probe
- Meet the CE test standards



Model #	Description
WP295002	148x40x15mm

VOLTAGE TESTER

- Measuring range: 100-250VAC
- Full-hard heat treated of the slotted tool holder, durable
- Transparent plastic handle with pen holder, easy to carry
- Meet the CE test standards



Model #	Description
WP295001	143x16x16mm

VOLTAGE TESTER

- Measuring range: 12-250VAC
- Fast induction test, safe and convenient
- LED display voltage display
- Meet the CE test standards



Model #	Description
WP295003	129x16x11mm

5PC ELECTRICAL TAPE

- 19mm wide, 9 meters long
- High toughness and viscosity, high flame retardancy
- 5 color rolls, which can be used for identification
- Passed UL certification



Model #	Description
WP296001	5pcs

10PC ELECTRICAL TAPE

- 19mm wide, 9 meters long
- High toughness and viscosity, high flame retardancy
- Passed UL certification



Model #	Description
WP296002	10pcs

MULTI PURPOSE WIRE STRIPPER

PATENTED INNOVATIVE DESIGN



Plastic Box
For easy storage

4 Specifications
Meets daily needs

3cm Depressed Square
Length measurements

Quickly Strips

Removable Sliding Panel
For cleaning scraps

Model #	Description
WP291010	53x53x42mm

ELECTRICIAN SCISSORS

CLEAN AND NON-SLIP CUTS

Stainless Steel Blades

Heat-treated, sturdy and durable

5 Stripping Holes
10-18AWG solid



Plastic Scabbard

Easy storage and protection



Bi-material Handle
Non-slip and durable



Model #	Description
WP294003	167x80x28mm

CABLE CUTTER

- High-quality steel
- Blackened and polished Head, the cutting edge is sharp and tough, and the cutting is smooth and powerful
- Can cut multi-strand copper and aluminum cables, not suitable for cutting iron wires, steel wires, and steel cable cores
- Blue glossy plastic handle, dirt-resistant and easy to clean



Model #	Description
WP293001	160mm
WP293002	210mm
WP293003	235mm

STRANDED WIRE STRIPPER

- High-quality stainless steel blades
- Heat treated blade, strong and durable
- Colorful wooden handle, looks beautiful and high-grade



Model #	Description
WP296001	122x43x11mm
WP296002	120x45x10mm

STRANDED WIRE STRIPPER

- Cuts and strips 10-22 AWG(0.6-2.6mm) wire
- Cleanly shears bolts
- Easy-to-read gauge markings
- Wire looping and bending holes
- Spring loaded for self-opening action



Model #	Description
WP291003	200mm, 10-22AWG, 0.8-2.6mm

MULTI-PURPOSE WIRE STRIPPER

- Cuts and threads popular bolts sizes (M3.5, M4, M2.5, M5, M4, M3)
- Crimps insulated and non-insulated terminals



Model #	Description
WP291003	200mm, 10-22AWG, 0.8-2.6mm

MULTI-PURPOSE WIRE STRIPPER

- Cuts and threads popular bolt sizes (M3.5, M4, M2.5, M5, M4, M3)
- Wire looping and bending holes
- Strong-gripping serrated nose
- Curved handles



Model #	Description
WP291004	178mm, 10-20AWG

MULTI-PURPOSE WIRE STRIPPER

- Head clamping, single-strand and multi-strand wire stripping function
- Cutting electrician screw function
- Scribing wire
- Bending copper wire and crimping



Model #	Description
WP291009	210x60x18mm

MULTI-PURPOSE WIRE STRIPPER

- Cuts & threads popular bolt sizes
- Ergonomic anti-slip grip handle



Model #	Description
WP291001	200mm

AUTOMATIC WIRE STRIPPER

3In1



Serrated Nose
Strong-gripping



Curved Handle



Model #	Description
WP291007	Capacity: 10-24 AWG (0.2-6mm²)

AUTOMATIC WIRE STRIPPER

- Capacity: 8-18 AWG (1-3.2mm)
- Wire is automatically gripped and stripped with the same motion
- Adjustable dial



Model #	Description
WP291006	168mm(6-1/2")

MINI WIRE STRIPPER

- Carbon Steel
- Adjustable handle screw to control wire diameter
- Non-slip plastic handle



Model #	Description
WP291005	Stripping range: 0.5-4mm, 6-24AWG

AUTOMATIC WIRE STRIPPER

- Stripping range: 0.2-6mm single stranded wire or flat wire
- Stripping length: up to 25mm
- Stripping and cutting 2 in 1



Model #	Description
WP291008	168mm

MINI WIRE STRIPPER

- Made of high-quality steel plate, durable
- Suitable for 4P/RJ22 connector, 6P/RJ11/RJ12 telephone crystal terminal, 8P/RJ45 network crystal terminal
- With stripping and cutting functions
- The handle adopts labor-saving ratchet structure, making it easier to use
- Bi-color soft rubber non-slip handle



Model #	Description
WP292001	215x69x21mm



INSULATED TOOLS

- INSULATED SCREWDRIVER
- INSULATED PLIERS
- INSULATED WRENCH
- INSULATED SHEARS
- INSULATED CABLE KNIFE
- VOLTAGE TESTER
- INSULATED HACKSAW
- VDE TOOL SET

INSULATED SCREWDRIVER

APPROVED FOR 1,000 V AC APPLICATION



Model #	Description
WP341001	SL 0.4x2.5x75mm
WP341002	SL 0.5x3.0x100mm
WP341003	SL 0.6x3.5x100mm
WP341004	SL 0.8x4.0x100mm
WP341005	SL 1.0x5.5x125mm
WP341006	SL 1.2x6.5x150mm
WP341007	PH 0x60mm

Model #	Description
WP341008	PH 1x80mm
WP341009	PH 2x100mm
WP341010	PH 3x150mm
WP341019	PZ 0x60mm
WP341020	PZ 1x80mm
WP341021	PZ 2x100mm
WP341022	PZ 3x150mm

INSULATED NUT DRIVER

- Anti-slip bi-material handle
- CR-V steel



Model #	Description
WP341011	6.0x125mm
WP341012	7.0x125mm
WP341013	8.0x125mm
WP341014	9.0x125mm
WP341015	10x125mm
WP341016	11x125mm
WP341017	12x125mm

INSULATED SCREWDRIVER

- Ergonomic grip handle
- CR-V steel



Model #	Description
WP341023	2.5X50mm
WP341030	3.5X75mm
WP341024	4x100mm
WP341025	5.5x150mm
WP341026	6.5x150mm
WP341027	PH 0X75mm
WP341028	PH 1X100mm
WP341029	PH 2X125mm

INSULATED COMBINATION PLIERS

- Anti-slip bi-material handle
- CR-V forged steel



Model #	Description
WP342001	160mm(6")
WP342002	180mm(7")
WP342003	200mm(8")

INSULATED LONG NOSE PLIERS

- Anti-slip bi-material handle
- CR-V forged steel



Model #	Description
WP342004	160mm(6")
WP342005	200mm(8")

INSULATED BENT NOSE PLIERS

- Ideal for gripping and cutting work
- Tapered and bent jaw for those hard to reach places
- CR-V forged steel



Model #	Description
WP342006	160mm(6")
WP342007	200mm(8")

INSULATED DIAGONAL PLIERS

- Designed for cutting soft and hard wire
- Narrow head style to be used in confined areas



Model #	Description
WP342008	160mm(6")

INSULATED HIGH LEVERAGE DIAGONAL PLIERS

- 20% less effort
- Anti-slip bi-material handle
- CR-V forged steel



Model #	Description
WP342009	180mm(7")

MINI DIAGONAL PLIERS

- Designed for cutting insulation on wire
- CR-V forged steel



Model #	Description
WP342010	160mm(6")

INSULATED WATER PUMP PLIERS

- Gripping surfaces with special hardened teeth
- CR-V forged steel



Model #	Description
WP342011	250mm(10")

INSULATED LONG NOSE PLIERS

- CR-V steel with Ni-Fe coating
- Bi-material ergonomic grip handle



Model #	Description
WP342012	160mm(6")
WP342013	200mm(8")

INSULATED DIAGONAL CUTTING PLIERS

- CR-V steel with Ni-Fe coating
- Bi-material ergonomic grip handle



Model #	Description
WP342014	160mm(6")

INSULATED DIAGONAL PLIERS

- CR-V steel with Ni-Fe coating
- Bi-material ergonomic grip handle



Model #	Description
WP342015	180mm(7")

INSULATED COMBINATION PLIERS

- CR-V steel with Ni-Fe coating
- Bi-material ergonomic grip handle



Model #	Description
WP342016	160mm(6")
WP342017	200mm(8")

INSULATED STRIPPER PLIERS

- CR-V steel with Ni-Fe coating
- Bi-material ergonomic grip handle



Model #	Description
WP342018	160mm(6")

INSULATED WATER PUMP PLIERS

- CR-V steel with Ni-Fe coating
- Bi-material ergonomic grip handle



Model #	Description
WP342019	250mm(10")

INSULATED ADJUSTABLE WRENCH

**GREATER CAPACITY
STRONGER GRIP**



CR-V Forged Steel



Variable Gripping Width
With scale



Model #	Description
WP343056	160mm(6")
WP343057	200mm(8")
WP343058	250mm(10")
WP343059	320mm(12")

INSULATED OPEN END WRENCH

- Jaw 15° angled
- CR-V steel
- Anti-slip bi-material handle



Model #	Description
WP343001	6mm
WP343002	7mm
WP343003	8mm
WP343004	9mm
WP343005	10mm
WP343006	11mm
WP343007	12mm
WP343008	13mm
WP343009	14mm
WP343010	15mm

Model #	Description
WP343011	16mm
WP343012	17mm
WP343013	18mm
WP343014	19mm
WP343015	21mm
WP343016	22mm
WP343017	24mm
WP343018	27mm
WP343019	30mm
WP343020	32mm

INSULATED RING WRENCH

- Ring head 75° offset
- CR-V steel
- Anti-slip bi-material handle



Model #	Description
WP343021	6mm
WP343022	7mm
WP343023	8mm
WP343024	9mm
WP343025	10mm
WP343026	11mm
WP343027	12mm
WP343028	13mm
WP343029	14mm
WP343030	15mm

Model #	Description
WP343031	16mm
WP343032	17mm
WP343033	18mm
WP343034	19mm
WP343035	21mm
WP343036	22mm
WP343037	24mm
WP343038	27mm
WP343039	30mm
WP343040	32mm

INSULATED RATCHET RING WRENCH

- 72 teeth ratchet
- CR-V steel
- Anti-slip bi-material handle



Model #	Description
WP343041	7mm
WP343042	8mm
WP343043	9mm
WP343044	10mm
WP343045	11mm
WP343046	12mm
WP343047	13mm
WP343048	14mm

Model #	Description
WP343049	15mm
WP343050	16mm
WP343051	17mm
WP343052	18mm
WP343053	19mm
WP343054	22mm
WP343055	24mm

INSULATED SCISSORS

- Anti-slip bi-material handle
- CR-V steel



Model #	Description
WP344009	160mm

INSULATED CABLE SHEARS

- Designed for use with aluminium and copper cables
- CR-V steel



Model #	Description
WP344001	160mm(22mm ²)

INSULATED LARGE CABLE SHEARS

- Designed For bruise-free cutting of copper and aluminum cables
- Clean and smooth cut
- CR-V Steel



Model #	Description
WP344002	250mm(80mm ²)

INSULATED CABLE KNIFE

- Fixed straight blade, stainless steel material
- Protective cap



Model #	Description
WP344004	50x180mm

INSULATED CABLE KNIFE

- Solid, fixed straight blade with protective cap
- Stainless steel blade
- Back of the blade plastic coated to avoid short circuits



Model #	Description
WP344006	50x180mm

INSULATED CABLE SHEARS

- Stainless steel blades
- Great for cut ϕ 6mm rebar



Model #	Description
WP344003	600mm

INSULATED CABLE KNIFE

- Narrow, fixed sickle-shaped hook blade
- Stainless steel blade
- Suitable for sector cables
- Protective Cap



Model #	Description
WP344005	50x180mm

INSULATED CABLE KNIFE

- Replaceable straight blade, stainless steel material
- Hinged blade guard integrated in the handle



Model #	Description
WP344007	48x185mm

CABLE KNIFE BLADE

- Stainless steel blade



Model #	Description
WP344008	58mm

VDE VOLTAGE TESTER

- For 125-250 V AC
- Fully insulated blade and handle
- Manufactured acc. to DIN VDE 0680
- S2 Steel



Model #	Description
WP349001	140mm

INSULATED HACKSAW

- Screw for tensioning the saw blade
- HSS saw blade



Model #	Description
WP349002	150mm

INSULATED SCREWDRIVER SET

- 8PC
- S2 Steel
- Portable transparent plastic box

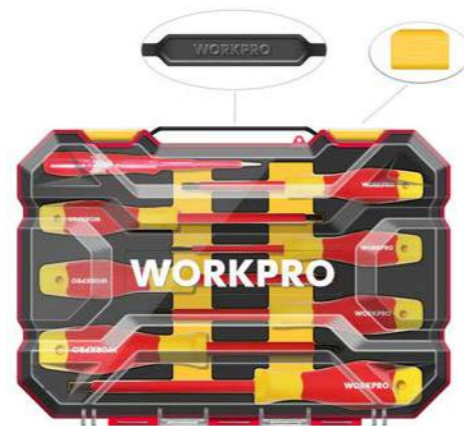

Model #	Description
WP204700	SL 0.6x3.5x100mm, SL 0.8x4x100mm, SL 1.0x5.5x125mm, SL 1.2x6.5x150mm; PH 0X60mm, PH 1X80mm, PH 2X100mm; Voltage Tester 3X70mm

12-IN-1 INSULATED CHANGEABLE SCREWDRIVER SET

MULTI-PURPOSE AND PORTABLE



Storage Bag



Slotted And Phillips Type

S2 Steel



Model #	Description
WP341018	12PC: 2.5x0.4x100mm, 3.0x0.5x100mm, 4.0x0.8x100mm, 5.5x1.0x100mm, 6.5x1.2x100mm, PH0x100mm, PH1x100mm, PH2x100mm, T15x100mm, T20x100mm, 31x118mm handle, 3x70mm voltage tester

INSULATED PLIERS SET

- 4 PC
- CR-V forged steel
- Portable transparent plastic box



Model #	Description
WP204703	160mm(6") combination pliers, 160mm(6") long nose pliers, 160mm(6") diagonal cutting pliers, 160mm(6") wire stripper



AUTOMOTIVE TOOLS

**GEAR PULLER
WRENCH
LIFTING GEAR
OTHER**

6-WHEEL PLASTIC CREEPER

- Heavy duty one-piece
- Body fitting design
- 6 extra ball bearing nylon castors



Model #	Description
WP319001	900mm(36"); Max.load 90kg
WP319002	1000mm(40"); Max.load 90kg

HYDRAULIC STOOL

- 4PC 65mm swivel castors
- Padded height-adjustable seat
- Heavy-duty construction



Model #	Description
WP319003	Max. load: 113kg; Height range: 42cm--54cm

CREEPER SEAT WITH DRAWERS

- Vinyl padded seat
- With drawers for storage
- 4PC 64mm castors

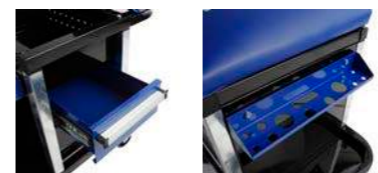

Model #	Description
WP319004	36x45x52cm; Max. load :150kg

UNIVERSAL FOLDING LUG WRENCH

- Drop forged steel
- Surface plated, durable and anti-corrosion
- Socket sizes: 17mm / 19mm / 21mm / 22mm
- Foldable design, convenient for storage



Model #	Description
WP314003	350mm(14")

LUG NUT WRENCH

- Drop forged steel
- Surface plated, durable and anti-corrosion
- Socket sizes: 17mm / 19mm / 21mm / 23mm



Model #	Description
WP314004	350mm(14")
WP314005	400mm(16")

GREASE GUN WITH HOSE

- Working pressure: 10000PSI
- Gray electric coating finish for service life
- Air vent head cap & positive lock for cartridge loading



Model #	Description
WP313001	Capacity: 400cc (14oz)
WP313002	Capacity: 600cc (21oz)

ROUND MAGNETIC PARTS TRAY

- Stainless steel
- Ideal for storage of small items
- Powerful magnet



Model #	Description
WP314001	148x24x38mm

RECTANGLE MAGNETIC PARTS TRAY

- Stainless steel
- Ideal for storage of small items
- Powerful magnet



Model #	Description
WP314002	238x137x40mm

4-CLAW PICK-UP TOOL

- Flexible shaft claw
- 4-prong 65 Mn claws
- Steel construction



Model #	Description
WP319005	600mm(24"); Max. load: 9kg(20lb)

FLEXIBLE SHAFT MAGNETIC PICK UP TOOL

- Powerful magnet
- 457.2mm(18") flexible shaft holds any angle



Model #	Description
WP319007	Length: 585±5mm

MAGNETIC PICK UP TOOL

- Stainless steel antenna
- Multi-angle ball joint neck
- Powerful magnet
- Extends up to 650mm



Model #	Description
WP319006	Max. length: 650mm

TELESCOPING INSPECTION MIRROR

- Stainless steel antenna
- Multi-angle ball joint neck



Model #	Description
WP319008	440mm; φ50mm
WP319009	720mm; φ55mm

ADJUSTABLE OIL FILTER WRENCH

- 60-102mm work range
- Easy to clean handle
- Sure-grip teeth prevent slipping



Model #	Description
WP319010	300mm(12")



2-JAW GEAR PULLER

- Made of heat treated drop-forged steel
- Adjustable sliding arm for efficiency and safety
- Reversible jaws for internal & external options gear, axle, bearing, etc.



Model #	Description
WP311001	Size: 90x100mm; Operating range: 90/70-130mm; Max. reach height: 100mm
WP311002	Size: 130x100mm; Operating range: 130/80-180mm; Max. reach height: 100mm
WP311003	Size: 160x150mm; Operating range: 160/105-220mm; Max. reach height: 150mm

3-JAW GEAR PULLER

- Made of heat treated drop-forged steel
- The 3-jaw design balances pulling force well
- Reversible jaws for internal & external options gear, axle, bearing, etc.



Model #	Description
WP311004	Size: 76.2mm(3"); Operating range: 15-80mm; Max. reach height: 75mm
WP311005	Size: 101.6mm(4"); Operating range: 20-100mm; Max. reach height: 100mm
WP311006	Size: 152.4mm(6"); Operating range: 25-160mm; Max. reach height: 150mm

300CC OIL CAN

- Selected high-quality steel
- 300CC capacity
- Suitable for lubrication of mechanical parts



Model #	Description
WP313003	300mm

1/2" DR. TELESCOPING LUG WRENCH

- Made of steel
- Electroplated, durable and anti-corrosion
- With 2PC double-ended sockets
- L-shaped bar wrench with 1/2" square drive
- Suitable for the disassembly and assembly of hexagonal screws



Model #	Description
WP314007	2PC double-ended sockets: 17x19mm, 21x23mm

ADJUSTABLE OIL FILTER WRENCH

- Made of 40CR for durability
- Chrome plated, anti-corrosion
- Suitable for disassembly and assembly of hexagonal screws

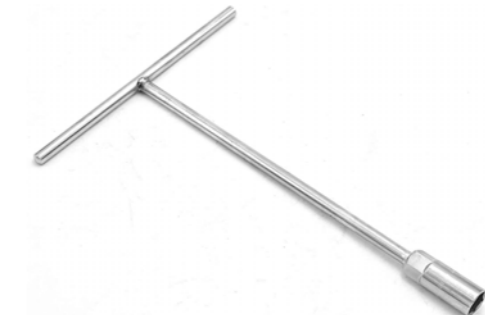

Model #	Description
WP314009	8mm
WP314010	9mm
WP314011	10mm
WP314012	11mm
WP314013	12mm
WP314014	13mm

Model #	Description
WP314015	14mm
WP314016	15mm
WP314017	16mm
WP314018	17mm
WP314019	19mm

3-WAY SOCKET WRENCH

- Made of 40CR for durability
- Chrome Plated, anti-corrosion
- 3 sizes in one wrench
- Suitable for disassembly and assembly of hexagonal screws



Model #	Description
WP314021	8x9x10mm
WP314022	8x10x12mm
WP314023	10x12x14mm

Model #	Description
WP314024	12x14x17mm
WP314025	14x17x19mm

6x6PT L-TYPE WRENCH

- 40CR, heat treated
- Fully polished
- 6x6PT Double socket



Model #	Description
WP314033	9mm, 6x6PT
WP314034	10mm, 6x6PT
WP314035	11mm, 6x6PT
WP314036	12mm, 6x6PT
WP314037	13mm, 6x6PT
WP314038	14mm, 6x6PT

Model #	Description
WP314039	15mm, 6x6PT
WP314040	16mm, 6x6PT
WP314041	17mm, 6x6PT
WP314042	18mm, 6x6PT
WP314043	19mm, 6x6PT

6x12PT L-TYPE WRENCH

- Carbon steel, heat treated
- Drop forged in one-piece, fully polished
- 6x12PT Double socket



Model #	Description
WP314044	9mm, 6x12PT
WP314045	10mm, 6x12PT
WP314046	11mm, 6x12PT
WP314047	12mm, 6x12PT
WP314048	13mm, 6x12PT
WP314049	14mm, 6x12PT
WP314050	15mm, 6x12PT

Model #	Description
WP314051	16mm, 6x12PT
WP314052	17mm, 6x12PT
WP314053	18mm, 6x12PT
WP314054	19mm, 6x12PT
WP314055	20mm, 6x12PT
WP314056	21mm, 6x12PT

SELF-ADJUSTING OIL FILTER WRENCH

- Made of high-quality 40CR-V
- Three jaws catch the filter more tightly
- Fits 63-102mm filters
- 1/2" Square Drive Head
- Perfect for most automotive and truck filters



Model #	Description
WP319011	1/2"DR. 3-jaw

SWIVEL OIL FILTER WRENCH

- 1" wide steel band for strong grip without crushing filter
- Comfortable vinyl coated handle
- 180 degree swivel action
- Perfect for most automotive and truck filters



Model #	Description
WP319012	70-82.5mm
WP319013	87-95mm
WP319014	105-115mm

5PC SCREW EXTRACTORS

- Made of GCR15
- PP box for storage
- Extractor Size: #1, #2, #3, #4, #5
- Perfect for removing screws and bolts with damaged heads



Model #	Description
WP319018	Extractor Size: #1, #2, #3, #4, #5

4PC PICK AND HOOK SET

- Comfortable bi-material rubber coating grip
- Carbon steel for strength and durability
- Perfect for scribing lines, o-ring and cotter pin removal, breaking connections

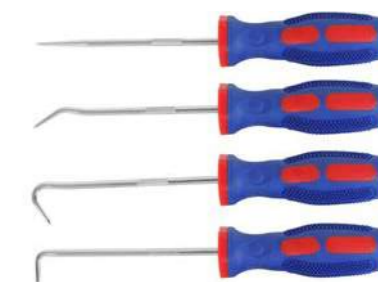

Model #	Description
WP319020	Includes: Straight Pick, Curved Hook, Complex Hook, 90 Degree Hook

4Mx5T TOW STRAP

- Suitable for towing vehicles up to 5T
- Forged steel slip hook with latch
- High-strength polyester webbing is mildew and rot resistant
- Carabineer-style hooks allow quick, easy attachments



Model #	Description
WP319025	4mx5T

RATCHET TIE DOWN

- High-strength polyester webbing is mildew and rot resistant
- Ratcheting buckle and double J hooks offer a secure attachment
- Can be used with trailers, hitches, automobiles, boats, etc.



Model #	Description
WP319026	Webbing size: 25mmx3m; Working load limit: 0.25T
WP319027	Webbing size: 35mmx6m; Working load limit: 1T
WP319028	Webbing size: 50mmx6m; Working load limit: 5T

Model #	Description
WP319029	Webbing size: 50mmx10m; Working load limit: 5T
WP319030	Webbing size: 50mmx12m; Working load limit: 5T



PLUMBING TOOLS

PIPE CUTTER
FLARING TOOL
TAP AND DIE SET
OTHER

ALUMINUM PIPE WRENCH

LIGHTWEIGHT

- Drop forged replaceable hook and heel jaws
- Aluminum handle



Model #	Description
WP302006	250mm(10")
WP302007	350mm(14")

Model #	Description
WP302008	450mm(18")
WP302009	600mm(24")

PIPE WRENCH

- Drop forged replaceable hook and heel jaws
- Iron handle



Model #	Description
WP302001	250mm(10")
WP302002	350mm(14")

Model #	Description
WP302003	450mm(18")
WP302004	600mm(24")

90° STRAIGHT JAW PIPE WRENCH

- 90° Angled jaws
- Captive adjusting nut



Model #	Description
WP302012	Size:300mm(12"); Max.φ:25mm(1")
WP302013	Size:400mm(16"); Max.φ:38mm(1-1/2")
WP302014	Size:560mm(22"); Max.φ:50mm(2")

35MM(1-1/4") PIPE CUTTER

- 65Mn replaceable blade
- Aluminum alloy case
- Ergonomic handle
- Suitable for cutting PVC, rubber, etc.



Model #	Description
WP301001	Max. cutting diameter: 35mm



42MM(1-5/8") PIPE CUTTER

**RATCHET AND QUICK RELEASE
MORE EFFICIENT**



Model #	Description
WP301002	Max. cutting diameter: 42mm

3-32MM(1/8"-1-1/4") ALUMINUM TUBE CUTTER

BEST CHOICE



Model #	Description
WP301005	Cutting range: 3-32mm (1/8"- 1-1/4")

3-30MM(1/8"-1-1/8") TUBING CUTTER

- Aluminum alloy
- Bearing steel blades
- With spare blades at the end
- With burr knife



Model #	Description
WP301004	Cutting range: 3-30mm(1/8"-1-1/8")

3-16MM(1/8"-5/8") TUBING CUTTER

- Durable zinc alloy body
- Bearing steel blade



Model #	Description
WP301003	Cutting range: 3-16mm(1/8"-5/8")

ALL-IN-ONE FLARING TOOLS

WIDE RANGE OF SIZES



Model #	Description
WP303001	240x215x60mm

FLARING TOOL

- 40CR clip, durable steel holder
- Corrosion-resistant surface
- Suitable for reaming and splicing of pipes



Model #	Description
WP303002	Imperial; O.D.: 5/8", 3/16", 1/4", 5/16", 3/8", 7/16", 1/2"
WP303003	Metric; O.D.: 5, 6, 8, 10, 12, 14, 16mm

3-IN-1 TUBE BENDER

- Aluminum alloy body
- Soft metal only



Model #	Description
WP303004	6mm, 8mm, 10mm

2-IN-1 HEAVY DUTY TUBE BENDER

- Aluminum alloy body
- Soft metal only
- Equipped with 2 arc-shaped slotted aluminum strips



Model #	Description
WP303005	15mm, 22mm

4PC SPRING TUBE BENDER SET

- Durable stainless steel
- Soft tube only



Model #	Description
WP303006	Length: 250mm(10")

SNAKE DRAIN AUGER

- Heat-treated spring
- Flexible serpentine design
- Suitable for removing drain clogs



Model #	Description
WP304001	4m

TOILET PLUNGER

- Used to unclog the toilet



Model #	Description
WP304002	Length: 480mm; Diameter: 145mm

ADJUSTABLE BASIN WRENCH

- Corrosion-resistant 40CR end
- Drop forged steel jaws
- Enhance force lever



Model #	Description
WP309002	Adjustable 10 - 32 mm capacity

5PC SHOWER VALVE WRENCH SET

- Electroplated seamless steel pipe



Model #	Description
WP309005	16.7x21.5mm, 23.0x24.6mm, 26.2x27.8mm, 29.4x32.6mm, 34.2x36.5mm

32PC TAP AND DIE SET

WIDE RANGE APPLICATION

32
PIECE MM



Alloy Steel
Heat-treated for durability



Iron Box
For convenient storage

Model #	Description
WP309008	Includes: Die: M3 x 0.5, M4 x 0.7, M5 x 0.8, M6 x 1.0, M8 x 1.25, M10 x 1.5, M12 x 1.75; Tap: 3 x M3 x 0.5, 3 x M4 x 0.7, 3 x M5 x 0.8, 3 x M6 x 1.0, 3 x M8 x 1.25, 3 x M10 x 1.5, 3 x M12 x 1.75; 1pc Tap Wrench; 1pc Die Stock; 1pc Pitch Gauge; 1pc Screwdriver.

INNER-OUTER TUBE REAMER

- Impact-resistant plastic case
- With 65Mn blades inside



Model #	Description
WP309006	Max.O.D. 42mm

12PC TAP AND DIE SET

- Repair of internal and external threads
- Bearing steel, heat-treated for durability
- Plastic box for convenient storage



Model #	Description
WP309009	Includes: M6 x 1.0, M7 x 1.0, M8 x 1.25, M10 x 1.50, M12 x 1.75; 1pc Tap Wrench; 1pc Die Stock.



MASONRY & PAINTING

CONCRETE TOOLS
MASONRY TOOLS
DRYWALL TOOLS
PAINT TOOLS
TILE TOOLS

BRICKLAYING TROWEL

POINTED SPATULA

High Carbon Steel Blade

Heat-treated for elasticity and durability

High Carbon Steel Blade

Heat-treated for elasticity and durability

Strength Increased

Ergonomic Soft Grip Handle

Reduces fatigue for comfortable use



Model #	Description
WP322007	150mm(6")
WP322008	180mm(7")
WP322009	200mm(8")

BRICKLAYING TROWEL WOOD HANDLE

- Carbon Steel
- Wooden handle
- Diameter of connecting rod:7.8mm



Model #	Description
WP322004	150mm(6")
WP322005	180mm(7")
WP322006	200mm(8")

BRICKLAYING TROWEL PLASTIC HANDLE

- Carbon Steel
- Plastic handle
- Diameter of connecting rod:7.8mm



Model #	Description
WP322001	150mm(6")
WP322002	180mm(7")
WP322003	200mm(8")



STAINLESS STEEL STUCCO TROWEL

STAINLESS STEEL BLADE

Ergonomic Plastic Handle
Reduces fatigue for comfortable use



Aluminum Die Casting

Heavy-duty design for better strength and durability

Square-Notch

Different sizes used for different size tiles

Fastened With Welded Steel Rivets

Stainless Steel Blade
Hardened and tempered for elasticity and durability



Model #	Description
WP323001	Size:280x130x0.7mm; Teeth:6x6mm
WP323002	Size:280x130x0.7mm; Teeth:8x8mm
WP323003	Size:280x130x0.7mm; Teeth:10x10mm
WP323004	Size:280x130x0.7mm; Teeth:6x10mm
WP323005	Size:280x130mm

FINISHING MASONRY TROWEL

- Plastering trowel with teeth
- Plastic handle
- Carbon Steel
- Comfortable PP and TPR grip



8x8mm



Model #	Description
WP323017	Size:305x115x0.7mm; Teeth:8x8mm

FINISHING TROWEL WOOD HANDLE

- Plastering trowel with teeth
- Carbon Steel
- Wooden handle



Model #	Description
WP323006	Size:280x120mm; Teeth:6x6mm
WP323007	Size:280x120mm; Teeth:8x8mm
WP323008	Size:280x120mm; Teeth:10x10mm
WP323009	Size:280x120mm; Teeth:6x10mm
WP323010	Size:280x120mm

FINE RUBBER FLOAT TROWEL

- Natural foam rubber pad for stucco surface finish
- Pad is securely cemented to high strength aluminum backing
- Ergonomic plastic handle for easy floating action
- For a coarse or fine texture surface



Model #	Description
WP323015	230x100x17mm

PLASTERING TROWEL WITH TEETH

- Plastering trowel with teeth
- Carbon Steel
- Ergonomic soft grip plastic handle for easy floating action



Model #	Description
WP323011	Size:230x100mm; Teeth:6x6mm
WP323012	Size:230x100mm; Teeth:8x8mm
WP323013	Size:230x100mm; Teeth:6x10mm
WP323014	ize:230x100mm

FINE RUBBER FLOAT TROWEL

- Material: Rubber
- Two rounded corners prevent damage to grout joints, and two square corners ensure complete
- High impact plastic handle



Model #	Description
WP323016	240x100x20mm





STAINLESS STEEL FLEX JOINT KNIFE

**IN THE THIN SECTION
STAINLESS STEEL**

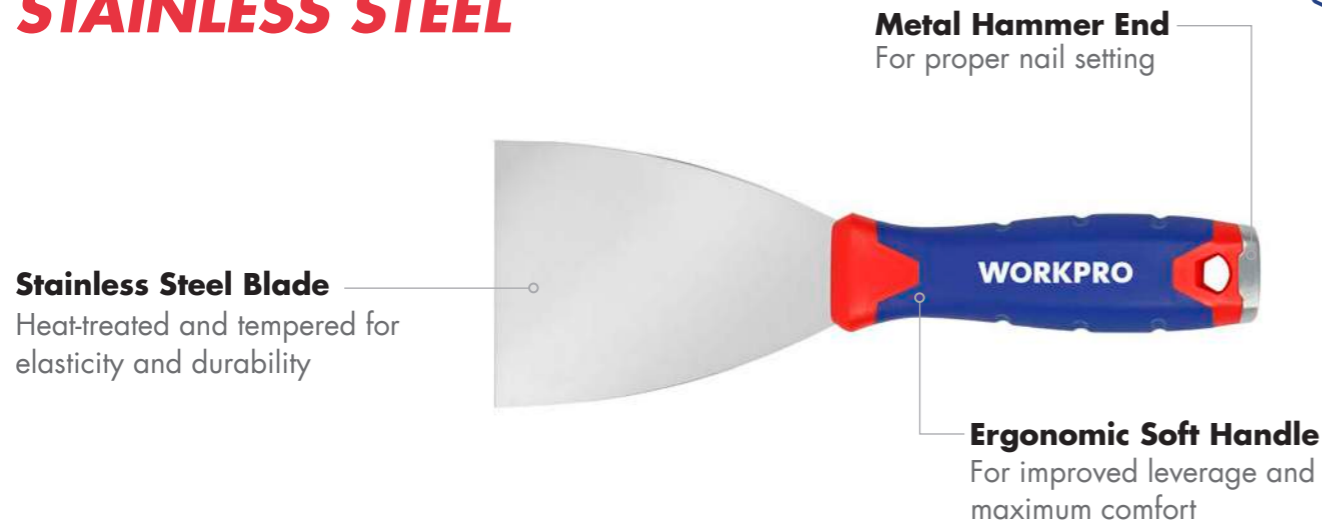

Model #	Description
WP321009	40mm
WP321010	60mm
WP321011	80mm
WP321012	100mm
WP321013	125mm
WP321014	150mm

STAINLESS STEEL STIFF JOINT KNIFE

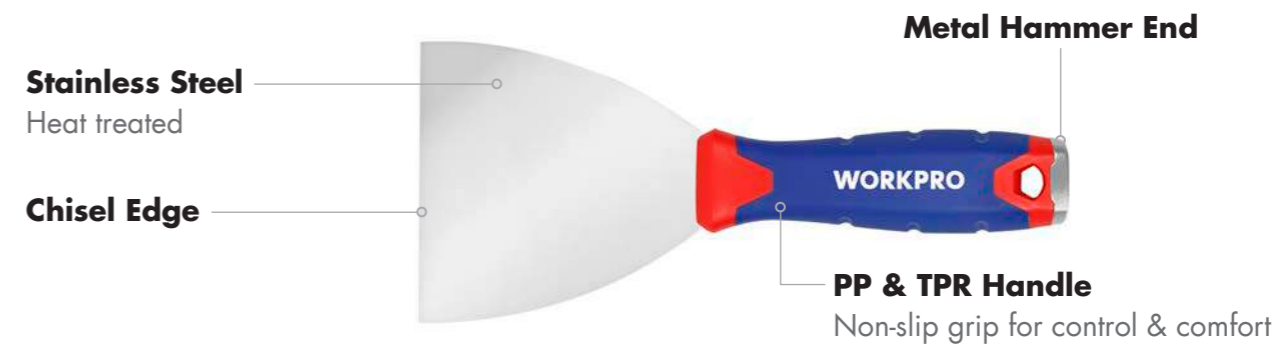

Model #	Description
WP321015	80mm

8-IN-1 SOFT GRIP STAINLESS STEEL PAINTERS TOOL

**MULTI-FUNCTION
STAINLESS STEEL**

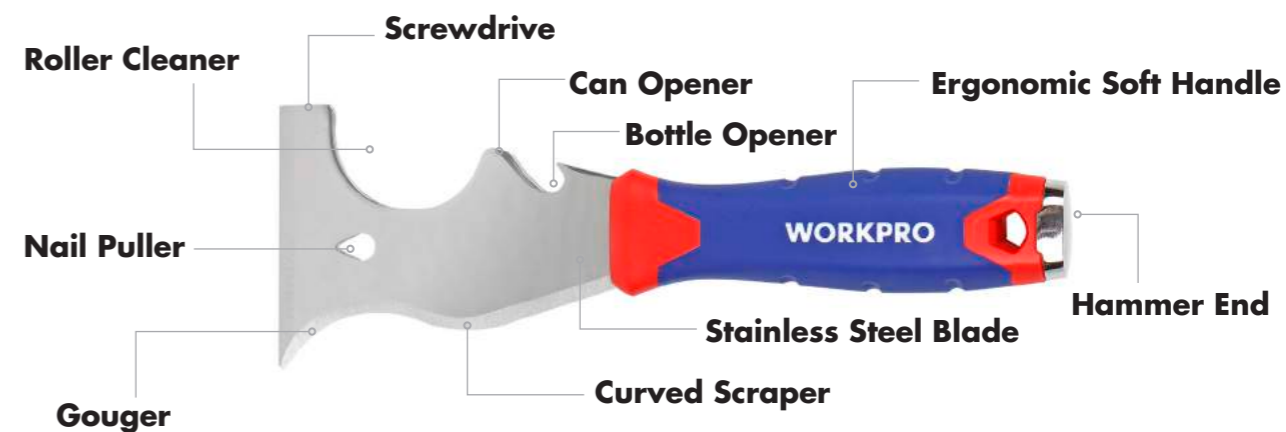

Model #	Description
WP321016	72mm

4PC PUTTY KNIFE SET

- Stainless steel, heat-treated
- Mirror polished
- Flexible
- Comfortable PP and TPR grip



Model #	Description
WP204306	40mm, 80mm, 100mm, 150mm

FLEX PUTTY KNIFE

- Carbon Steel, heat-treated
- Fine polished
- Flexible
- Plastic handle

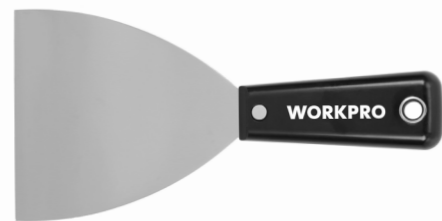

Model #	Description
WP321001	40mm
WP321002	60mm
WP321003	80mm
WP321004	100mm
WP321005	125mm
WP321006	150mm

STIFF PUTTY KNIFE

- Carbon Steel, heat-treated
- Fine polished
- Stiff
- Plastic handle



Model #	Description
WP321007	80mm

5-IN-1 PLASTIC HANDLE PAINTER'S TOOL

- Carbon Steel, heat-treated
- Fine polished

Straight Scraper



Model #	Description
WP321008	72mm

3PC PUTTY KNIFE SET

- Carbon Steel, heat-treated
- Fine polished
- Flexible
- Plastic handle



Model #	Description
WP204305	40mm, 60mm, 80mm

FLEX PUTTY KNIFE

- Carbon steel, heat-treated
- Mirror polished
- Flexible
- Metal hammer end
- Comfortable PP and TPR grip



Model #	Description
WP321019	50mm(2")
WP321020	75mm(3")

Model #	Description
WP321021	100mm(4")
WP321022	150mm(6")

5-IN-1 PAINTER'S TOOL

- Carbon steel, heat-treated
- Mirror polished

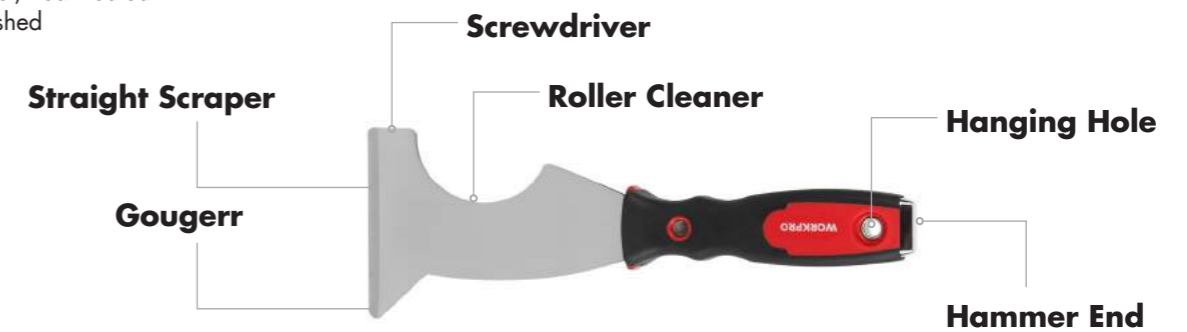

Model #	Description
WP321023	72mm

4PC WALL SCRAPER SET

- High quality tool steel
- Fine polished
- Flexible
- Plastic handle



Model #	Description
WP321017	50mm, 80mm, 100mm, 120mm

3PC PLASTIC JOINT KNIFE SET

- Plastic



Model #	Description
WP321018	38mm, 75mm, 150mm

STAINLESS STEEL TAPING KNIFE

STAINLESS STEEL

Aviation Aluminum Backplane
Reinforced and anodized for durability



Model #	Description
WP321032	200mm(8")
WP321033	250mm(10")
WP321034	300mm(12")
WP321035	350mm(14")

BLUE STEEL TAPING KNIFE

- 65Mn blade, heat-treated
- Blue finished surface
- Comfortable PP and TPR grip



Model #	Description
WP321024	200mm(8")
WP321025	250mm(10")
WP321026	300mm(12")
WP321027	350mm(14")

BLUE STEEL TAPING KNIFE

- 65Mn blade, heat-treated
- Blue finished surface
- Plastic handle



Model #	Description
WP321028	200mm(8")
WP321029	250mm(10")
WP321030	300mm(12")
WP321031	350mm(14")

STAINLESS STEEL MUD PAN

- Stainless steel



Model #	Description
WP329025	300mm(12")

INSIDE CORNER TOOL

- Stainless steel
- Comfortable PP and TPR grip

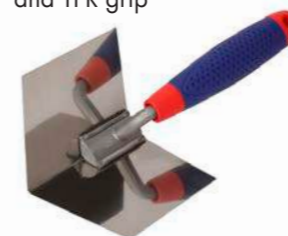

Model #	Description
WP323019	82.5x70mm

WIRE TWISTER

- Used to twist wire bar ties with a minimum of effort
- Two or three twists and the tie is completed
- Heavy duty hook is electroplated for corrosion resistance
- Selected contoured hardwood handle



Model #	Description
WP329032	

BANJO-DRY TAPE

- The original drywall tape banjo
- One-handed mud and tape loading
- Made of rugged, lightweight aluminum
- Holds up 152M of drywall tape
- Adjustable side strap and thumb rest included
- Tape and mud occupy the same one cavity



Model #	Description
WP329021	58x25x8.3cm

OUTSIDE CORNER TROWEL

- Outside sheetrock corner tool
- Stainless steel
- Comfortable pp and tpr grip



Model #	Description
WP323018	89x60.5mm

ALUMINIUM PLASTERING HAWK

- Material: Aluminum
- Wooden handle



Model #	Description
WP329014	330x330x1.5mm

WHITE NYLON LINE

- #18 nylon line
- Built-in elasticity maintains tension, eliminates sagging
- Abrasion and alkali resistant
- Solid bright colors for high visibility
- Twisted line up to 90 LBS



Model #	Description
WP329033	75m(250ft)

WALL PATCH

- Easily repair walls and ceilings
- Self adhesive fiberglass mesh holds patch firmly into place
- Rustproof aluminum base
- Easy to install



Model #	Description
WP329022	100x100mm(4"x4"); 2PC
WP329023	150x150mm(6"x6"); 2PC
WP329024	200x200mm(8"x8"); 2PC

WOODEN HANDLE FLAT PAINT BRUSH

HARD WOOD HANDLE SYNTHETIC FILAMENT

- 50% PET & 50% PBT and stainless steel ferrule
- Wooden handle
- The tail hanging hole



Model #	Description
WP325009	25mm(1")
WP325010	38mm(1.5")
WP325011	50mm(2")

Model #	Description
WP325012	63mm(2.5")
WP325013	75mm(3")
WP325014	100mm(4")

WOODEN HANDLE ANGLE PAINT BRUSH

- 50% PET & 50% PBT and stainless steel ferrule
- Wooden handle
- The tail hanging hole



Model #	Description
WP325007	38mm(1.5")

Model #	Description
WP325008	63mm(2.5")

3PC WOODEN HANDLE PAINT BRUSH SET

HARD WOOD HANDLE SYNTHETIC FILAMENT

- 25 & 38 & 50mm paint brushes
- 50% PET & 50% PBT and stainless steel ferrule
- Wooden handle
- The tail hanging hole



Model #	Description
WP204301	1pc 25mm(1"), 1pc 38mm(1.5"), 1pc 50mm(2")

FLAT PAINT BRUSH

- Special formulated PET and chrome plated ferrule
- Ergonomic handle with anti-skid design
- The tail hanging hole



Model #	Description
WP325001	25mm(1")
WP325002	38mm(1.5")
WP325003	50mm(2")
WP325004	63mm(2.5")
WP325005	75mm(3")
WP325006	100mm(4")

ANGLE PAINT BRUSH

- Special formulated PET and chrome plated ferrule
- Ergonomic handle with anti-skid design
- The tail hanging hole



Model #	Description
WP325007	38mm(1.5")
WP325008	63mm(2.5")

5PC PLASTIC HANDLE PAINT BRUSH SET

- 25 & 38 & 50mm Paint brushes and 38 & 63mm Angle Brushes
- Special formulated PET and chrome plated ferrule
- Ergonomic handle with anti-skid design
- The tail hanging hole
- 25 & 38 & 50mm Paint brushes and 38 & 63mm Angle Brushes
- Special formulated PET and chrome plated ferrule
- Ergonomic handle with anti-skid design
- The tail hanging hole



Model #	Description
WP204300	1pc 25mm(1") paint brush, 1pc 38mm(1.5") paint brush, 1pc 38mm(1.5") angled brush, 1pc 50mm(2") paint brush, 1pc 63mm(2.5") angled brush

PAINT ROLLER

EXTENDABLE

Roller Cover
High density shed resistant

Polyester Fabric
High density shed resistant



PP&TPR Grip
Extendable and comfortable



Model #	Description
WP324008	100mm(4")
WP324009	180mm(7")

Model #	Description
WP324010	230mm(9")
WP324011	255mm(10")

PAINT ROLLER

EXTENDABLE

- Finest quality high density shed resistant polyester fabric
- Match with unique handle
- Convenient and fast change the roller cover
- With 4pcs assistant shank
- Extendable, comfortable PP and TPR grip



Model #	Description
WP324012	180mm(7")
WP324013	230mm(9")
WP324014	270mm(10")

PAINT ROLLER

- Finest quality high density shed resistant polyester fabric
- Match with Unique handle
- Convenient and fast change the roller cover
- With 1 pc roller cover
- Extendable plastic handle



Model #	Description
WP324001	100mm(4")
WP324002	180mm(7")
WP324003	230mm(9")
WP324004	255mm(10")

PAINT ROLLER

- Finest quality high density shed resistant polyester fabric
- Fibre height: 12mm
- Perform well with all paints
- Sturdy solvent resistant core is easy to clean and reuse
- Finest quality high density shed resistant polyester fabric
- Holds a large amount of paint and releases evenly



Model #	Description	Model #	Description
WP324015	100mm(4")	WP324017	230mm(9")
WP324016	180mm(7")	WP324018	255mm(10")

4PC PAINT KIT

- Tested to ensure smooth and even application with one-coat
- Sturdy solvent resistant core is easy to clean and reuse
- Finest quality high density shed resistant polyester fabric
- Holds a large amount of paint and releases evenly



Model #	Description
WP204303	1pc 100mm(4") paint roller, 2pc 100mm(4") roller cover, 1pc 100mm(4") paint tray

ROLLER COVER

- Fibre height: 12mm
- Polyester fabric
- Perform well with all paints
- Sturdy solvent resistant core is easy to clean and reuse



Model #	Description
WP324019	180mm(7")
WP324020	230mm(9")
WP324021	255mm(10")

8PC PAINT KIT

- Most popular paint applicators combined to offer paint project solutions for great value
- Kit includes tools to paint an entire room with smooth application
- Tested to ensure smooth and even application with one-coat
- Sturdy solvent resistant core is easy to clean and reuse
- Finest quality high density shed resistant polyester fabric
- Holds a large amount of paint and releases evenly



Model #	Description
WP204304	1pc 100mm(4") paint roller, 2pc 100mm(4") roller cover, 1pc 230mm(9") paint roller, 1pc 230mm(9") roller cover, 1pc 230mm(9") paint tray, 1pc 230mm(9") PVC lined tray, 1pc 50mm(2") wooden handle flat paint brush, 2pc 50mm(2") sponge brush

HEAVY DUTY MANUAL TILE CUTTER

- Heavy duty tile cutter
- Top professional tile cutter
- For parallel & angled cuts
- Stopping rod support mass tile cutting
- YG6X Blade



Model #	Description
WP326002	600mm(24")
WP326003	800mm(32")
WP326004	1000mm(40")
WP326005	1200mm(48")

HEAVY DUTY TILE CUTTER

- Cuts up to 12mm thick
- YG6X blade
- Replace cutting blades
- For parallel & angled cuts



Model #	Description
WP326006	600mm(24")
WP326007	800mm(32")
WP326008	1000mm(40")
WP326009	1200mm(48")

MANUAL TILE CUTTER

- Replace cutting blades: $\phi 22 * \phi 6 * 2MM$ Cuts up to 12mm thick
- Sliding ball support large tile moving
- Comfortable PP and TPR grip



Model #	Description
WP326001	600mm(24")

HARD PLASTIC TILE SPACER

- Helps evenly space and align wall or floor tiles
- Leave-in design saves time and help avoid cracks in finished grout



Model #	Description
WP329034	Size:2mm; 250PC/PACK
WP329035	Size:3mm; 250PC/PACK
WP329036	Size:5mm; 250PC/PACK

DRYWALL PANEL CARRIER

- Handle is offset to keep sheet materials away from hands
- Durable high impact plastic construction
- Enables one person to easily carry sheet materials
- Carry plywood and drywall sheets easily



Model #	Description
WP329001	350mm(14")

DRYWALL STRIPPER

- Adjustable cutting depth
- Replacement blades available
- Comfortable to grip



Model #	Description
WP329020	Twinn cutting blades 65MN

LAMINATE AND WOOD FLOORING INSTALLATION KIT

- Double-faced solid rubber head delivers a softened. The mallet head is 40 mm in diameter
- 310mm long, 4.5mm thick upgraded pull bar is more longer and thicker than others
- 30 spacers included, allow you to install your laminate wood flooring more convenient and easier
- Suitable for 0.27in (7mm) - 0.6in (15mm) laminate or hardwood flooring
- Package included 1 x rubber hammer, 1 x pull bar, 1 x tapping block, 30 x spacers



Model #	Description
WP204302	1pc rubber hammer, 1pc pull bar, 1pc tapping block, 30pcs spacers

100PC CABLE TIES

- Nylon PA66
- Heat resistant & Heavy Duty
- Easy to use



Model #	Description
WP329004	2.5x100mm, white
WP329030	3.6x150mm, white
WP329005	3.6x200mm, white
WP329006	4.8x300mm, white
WP329007	7.2x400mm, white
WP329008	9x500mm, white

Model #	Description
WP329009	2.5x100mm, black
WP329031	3.6x150mm, black
WP329010	3.6x200mm, black
WP329011	4.8x300mm, black
WP329012	7.2x400mm, black
WP329013	9x500mm, black

ALUMINUM SUCTION CUP

- Maximum bearing capacity: 45KG
- Material: Rubber & Aluminum alloy



Model #	Description
WP329038	115mm(4.5")

ALUMINUM TWOSOME SUCTION CUP

- Maximum bearing capacity: 90KG
- Material: Rubber & Aluminum alloy



Model #	Description
WP329039	115mm(4.5")

ALUMINUM TRIPLE SUCTION CUP

- Maximum bearing capacity: 135KG
- Material: Rubber & Aluminum alloy



Model #	Description
WP329040	115mm(4.5")

PLASTIC SUCTION CUP

- Maximum bearing capacity: 30KG
- Material: Rubber & ABS



Model #	Description
WP329002	115mm(4.5")

PLASTIC TWOSOME SUCTION CUP

- Maximum bearing capacity: 60KG
- Material: Rubber & ABS



Model #	Description
WP329003	115mm(4.5")

PLASTIC TRIPLE SUCTION CUP

- Maximum bearing capacity: 90KG
- Material: Rubber & ABS



Model #	Description
WP329037	115mm(4.5")



OUTDOOR TOOLS

**OUTDOOR KNIFE
MULTIFUNCTIONAL TOOL
OUTDOOR SAW**

MULTI-PURPOSE PLIERS

15in1

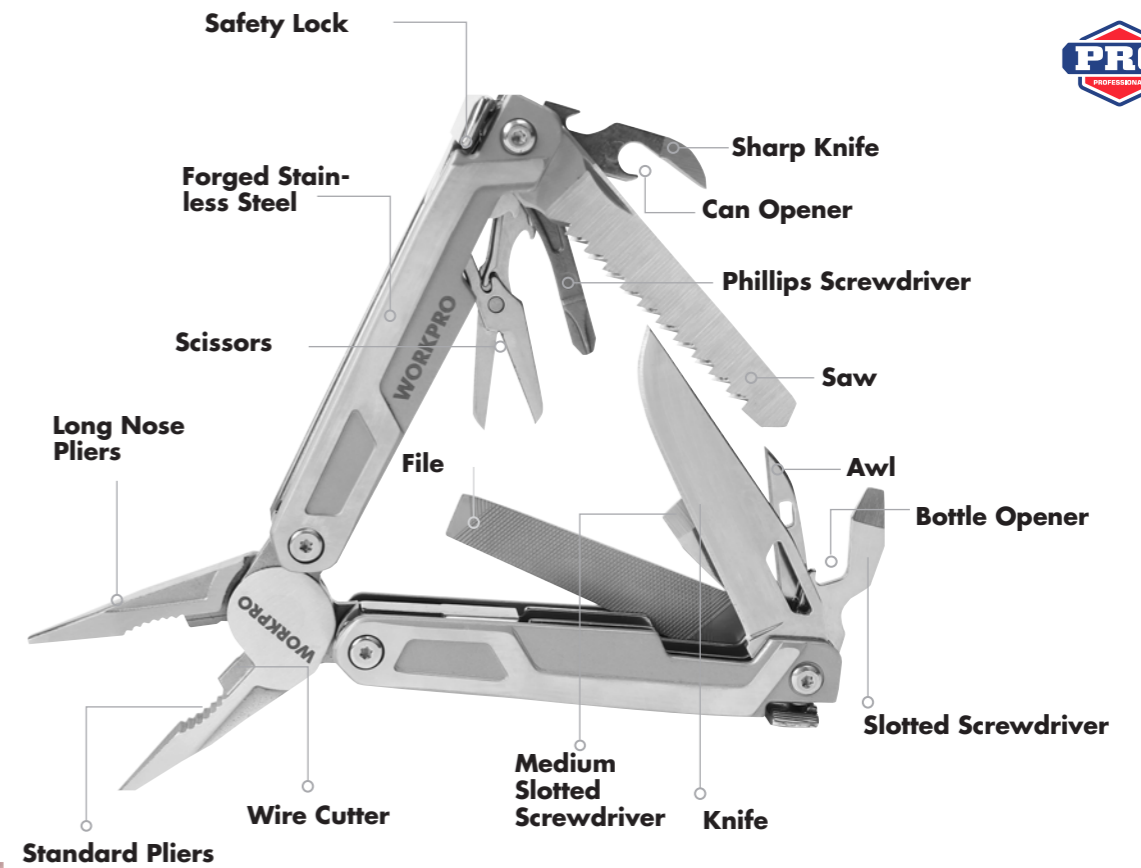

Model #	Description
WP382002	200/112x28x18mm

12-IN-1 MULTI-PURPOSE SCISSORS

- Forged stainless steel handle and components
- Include: wood/metal file, knife, bottle opener, medium size slotted screwdriver, awl, slotted screwdriver, philips screwdriver, can opener, serrated blade, saw, spring-loaded scissors with latch



Model #	Description
WP382007	Length: 163mm

16-IN-1 MULTI-PURPOSE PLIERS

- Sturdy stainless steel construction
- Include: long nose pliers, wire cutter, curved jaw pliers, hang hole, can opener, wire stripper, phillips screwdriver, serrated blade, saw, hardwire cutters, knife, file, slotted screwdriver (M/L), reamer, bottle opener



Model #	Description
WP382008	Length: 178mm



15-IN-1 MULTI-PURPOSE PLIERS

- Convenient, easily accessible butterfly opening
- Sturdy stainless steel construction
- Include: long nose plier, wire cutter, curved jaw plier, bottle opener, can opener, phillips screwdriver, saw, knife, file, scissors, slotted screwdriver (S/M/L)



Model #	Description
WP382009	Length: 150mm

12-IN-1 MINI MULTI-PURPOSE PLIERS

- Stainless steel blades and tools
- Multi-functions for all basic applications: file, Phillips screwdriver, slotted screwdriver, saw blade, knife, pliers, scissors



Model #	Description
WP382017	Length: 110mm

15-IN-1 MULTI-PURPOSE PLIERS

- Black alumina handle
- Stainless steel jaws and accessories: slotted screwdriver, Phillips screwdriver, knife, bottle opener, medium-sized slotted screwdriver, awl, file with large slotted screwdriver



Model #	Description
WP382003	160mm

12-IN-1 MULTI-PURPOSE PLIERS

- Durable and anti-corrosion stainless steel
- Lighter hollow handle
- Stainless steel accessories: blade, file, Phillips screwdriver, small slotted screwdriver; saw blade, medium slotted screwdriver, knife, can opener



Model #	Description
WP382001	165x65x17mm

5-IN-1 MULTI-PURPOSE TOOL

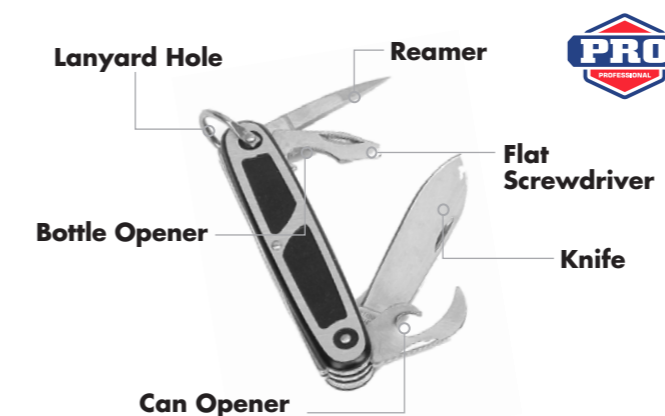

Model #	Description
WP382010	Length: 92mm

MULTI-PURPOSE GARDEN SHEARS



Model #	Description
WP382005	185/125X50X15mm

7-IN-1 MULTI-PURPOSE KEY CHAIN

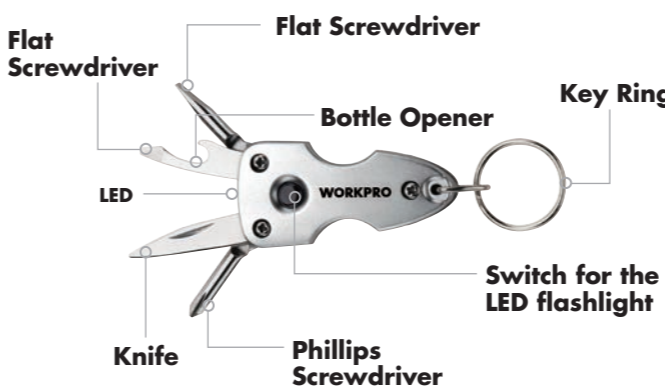

Model #	Description
WP382004	Weight: 60g

12-IN-1 MULTI-PURPOSE AXE



Model #	Description
WP383001	155x76x23mm

PARACORD AXE HATCHET

- Rust-resistant blade with 3 sizes of hex wrenches (3/8", 1/2", and 5/8")
- 10" Para cord wrapped handle with a tether
- Magnesium alloy fire starter
- Convenient carrying case with a velcro strap
- Small enough, flat enough to stow anywhere
- A great hatchet for camping or fishing



Model #	Description
WP383002	Length: 254mm (10")

FOLDING KNIFE WITH WOODEN HANDLE

- Rust-resistant 7CR17 blade
- Good quality wood handle
- Liner lock



Model #	Description
WP381001	115mm
WP381002	89mm
WP381003	140mm

4" FOLDING KNIFE

- Rust-resistant stainless steel blade
- Black finish
- Liner lock



Model #	Description
WP381008	Length: 102mm(4")

1.5" FOLDING KNIFE

- Rust-resistant stainless steel blade
- Great for everyday carry on a keychain
- Liner lock



Model #	Description
WP381009	Length: 38mm(1.5")

DAGGER WITH PLASTIC SCABBARD

- 7Cr17 material blade, surface polishing effect
- Dual-color handle PP+TPE
- Black PP scabbard



Model #	Description
WP381010	Length: 102mm(4")

KNIFE SHARPENER

- Tungsten steel/ceramic grinding part
- With portable and durable chain, suitable for outdoor use



Model #	Description
WP389001	90x30x8mm

MULTI-PURPOSE KEY CHAIN

- Unzip fingertips rotation, bottle opener function
- LED emergency lighting
- 360 degree rotate



Model #	Description
WP389004	80x40mm

SURVIVAL POCKET CHAINSAW

- Fast and convenient to saw and cut
- Very suitable for outdoor enthusiasts



Model #	Description
WP389005	11T

7-IN-1 EMERGENCY TOOL

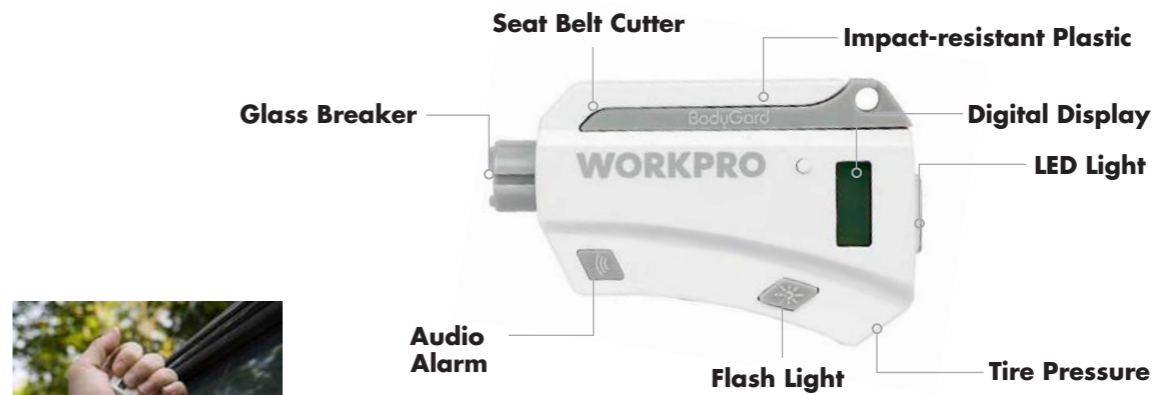

Model #	Description
WP319024	Length: 81.5mm; Weight: 42.7g

3-IN-1 EMERGENCY TOOL

- Impact-resistant plastic
- Automatic glass breaking function
- Seat belt cutter
- LED light



Model #	Description
WP319022	Length: 75mm; Weight: 25g

5-IN-1 EMERGENCY TOOL

- Impact-resistant plastic
- Automatic glass breaking function
- Seat belt cutter
- LED light
- Audio alarm
- Red light flashing function



Model #	Description
WP319023	Length: 81.5mm; Weight: 42.7g

4-IN-1 EMERGENCY HAMMER TOOL



Model #	Description
WP319021	Length:135mm

KEY KNIFE

- Blade smartly hidden in a key-shaped handle
- Lock back with handle the size and shape of a key
- Great for everyday carry on a keychain
- Length: 63.5mm(2.5")



Model #	Description
WP381004	Black
WP381005	Red
WP381006	Pink
WP381007	Yellow

6-IN-1 MULTI-PURPOSE SURVIVAL TOOL

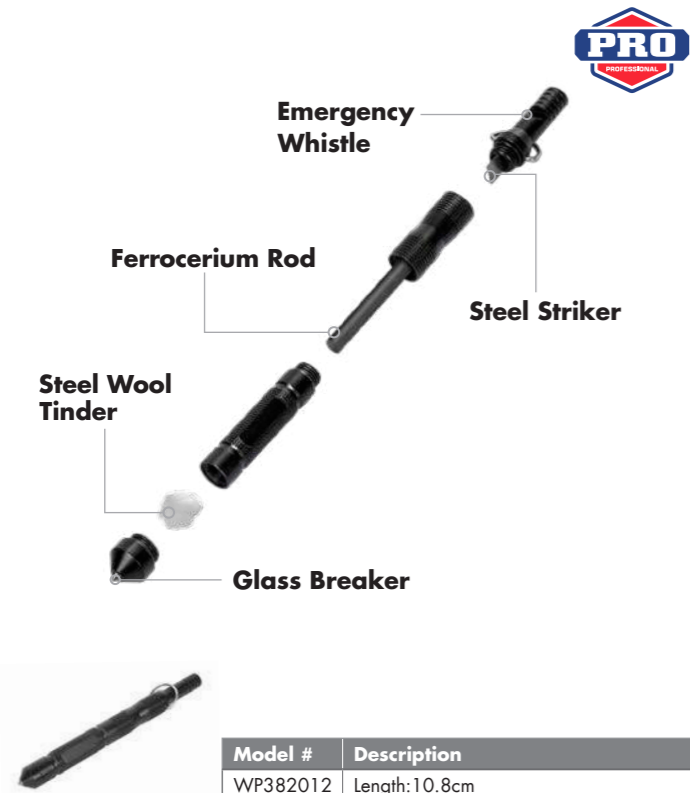

Model #	Description
WP382012	Length:10.8cm

11-IN-1 POCKET TOOL

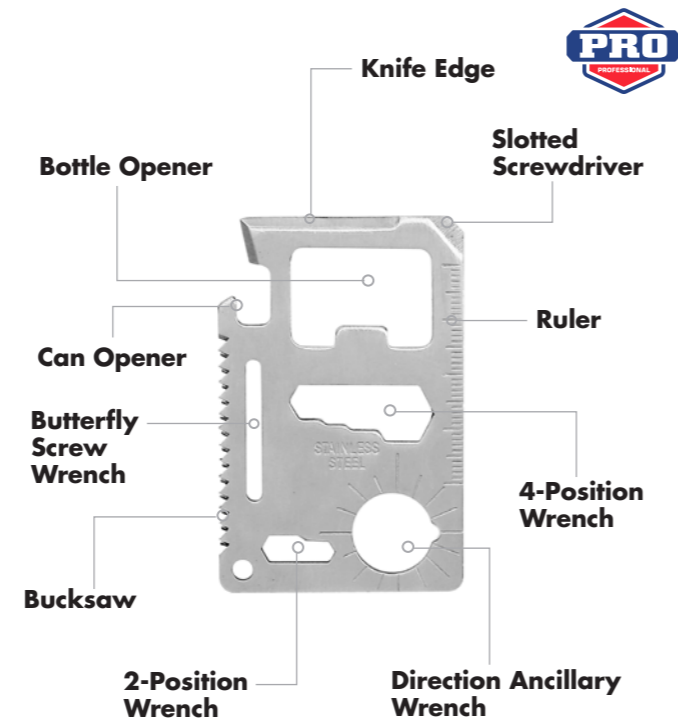

Model #	Description
WP382013	Size:6.9x4.5cm

8-IN-1 EDC TOOL

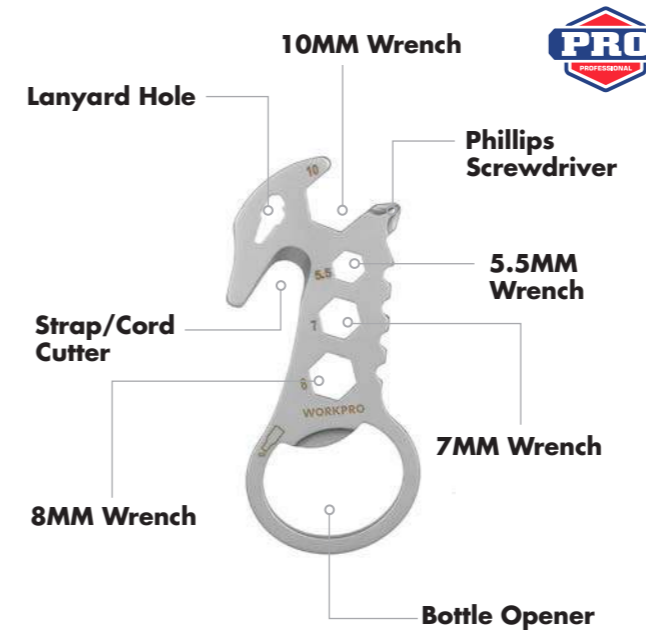

Model #	Description
WP382014	Length:75mm

10-IN-1 EDC TOOL

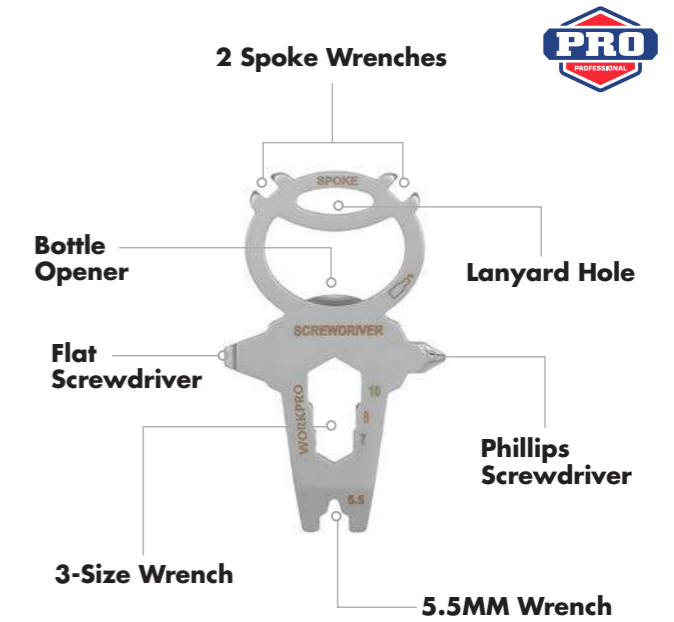

Model #	Description
WP382015	Length:70mm

9-IN-1 MINI FISHING MULTI TOOL

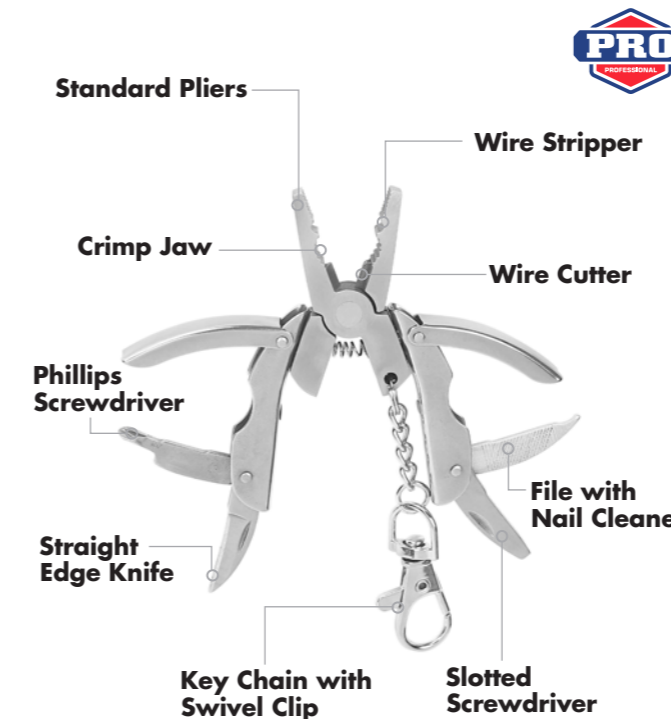

Model #	Description
WP382016	Length:7.8cm

SPRINGLOADED D-SHAPED CARBINERS

- 2 Carabiners included
- Made from aluminum construction
- Spring-loaded for easy operation
- Lightweight, strong and durable
- Not rated for climbing or safety applications



Model #	Description
WP389006	2pcs; Size:6cm;Max. working load: 60lbs
WP389007	2pcs; Size:8cm; Max. working load: 150lbs



WORKPRO®
TUMBLER & MUG

MULTICOLOR AVAILABLE

INSULATED TUMBLER WITH LID

WIDE MOUTH



Two colors available:



Model #	Description
WP389012	Red; 887ml(30oz)
WP389013	Red; 591ml(20oz)
WP389022	Cyan; 591ml(20oz)

Model #	Description
WP389029	Cyan; 887ml(30oz)
WP389023	White; 591ml(20oz)
WP389024	Black; 591ml(20oz)

INSULATED TUMBLER WITH LID AND HANDLE

VACUUM INSULATED



Two colors available:



PP Leak Proof Lid

Model #	Description
WP389020	Cyan; 709ml(24oz)
WP389021	WP389021 Red; 709ml(24oz)

INSULATED TUMBLER WITH LID AND HANDLE

VACUUM INSULATED



Two colors available:



Model #	Description
WP389014	Red; 413ml(14oz)
WP389030	Cyan; 413ml(14oz)

DOUBLE WALL STAINLESS STEEL INSULATED BOTTLE

*STAY HOT
KEEP COOL*



Two colors available:



Model #	Description
WP389016	Red; 532ml(18oz)
WP389017	Red; 1419ml(48oz)

Model #	Description
WP389032	Cyan; 532ml(18oz)
WP389033	Cyan; 1419ml(48oz)

DOUBLE WALL STAINLESS STEEL INSULATED TUMBLER WITH LID

*STAY HOT
KEEP COOL*



Two colors available:



Model #	Description
WP389015	Red; 295ml(10oz)
WP389031	Cyan; 295ml(10oz)

DOUBLE LAYER STAINLESS STEEL PINT CUP

VACUUM INSULATED



Two colors available:



Model #	Description
WP389011	Red; 473 ml
WP389028	Cyan; 473 ml

INSULATED TUMBLER SET

- Stainless steel #304
- Powder coating
- BPA free lid
- Durable, sturdy and delicately designed



Model #	Description
WP389018	Red; 591 ml(20oz)+295ml(10oz)
WP389034	Cyan; 591 ml(20oz)+295ml(10oz)

INSULATED TUMBLER SET

- Stainless steel #304
- Powder coating
- BPA free lid
- Durable, sturdy and delicately designed



Model #	Description
WP389019	Red; 591 ml(20oz)+413ml(14oz)
WP389035	Cyan; 591 ml(20oz)+413ml(14oz)



2PC STAINLESS STEEL CUP

- Stainless steel #304
- Powder coating
- BPA free lid
- Durable, sturdy and delicately designed



Model #	Description
WP389010	Red; 591 ml(20oz)
WP389027	Cyan; 591 ml(20oz)

4PC STAINLESS STEEL PINT CUP

- Stainless steel #304
- Powder coating
- BPA free lid
- Durable, sturdy and delicately designed



Model #	Description
WP389008	Red; 413ml(14oz)
WP389009	Red; 473mm(16oz)
WP389025	Cyan; 413ml(14oz)
WP389026	Cyan; 473mm(16oz)



QUAD FOLD WAGON

- Fabric material 600D polyester, frame material steel
- 360° beach wheels & adjustable handle & brake
- No assembly required
- Folding into the carry bag for convenient storage

ADJUSTABLE HANDLEBAR

Locking System is more secure and extends service life



Push down



Model #	Description
WP285015	Maximum load: 80kg; Capacity: 850x500x370mm ³

HEAVY DUTY QUAD FOLD WAGON

- Fabric material 600D polyester, frame material steel
- 360° beach wheels & adjustable handle & brake
- No assembly required
- Folding into the carry bag for convenient storage



Model #	Description
WP285016	Maximum load: 100kg; Capacity: 850x500x370mm ³





MANUAL GARDEN TOOLS

HAND CULTIVATOR
HAND FORK
WEEDER
TROWEL
SCISSORS
GARDEN TOOL SET

BYPASS PRUNER

19mm
3/4 INCH
MAX DIA.

SK5 BLADE
SOFT-GRIP BI-MATERIAL HANDLE



Model #	Description
WP332009	215mm

ANVIL PRUNER

19mm
3/4 INCH
MAX DIA.

SK5 BLADE
SOFT-GRIP BI-MATERIAL HANDLE



Model #	Description
WP332010	215mm

BYPASS PRUNER

19mm
3/4 INCH
MAX DIA.

SK5 BLADE
AL CASTING HANDLE



Model #	Description
WP332011	215mm

ANVIL PRUNER

19mm
3/4 INCH
MAX DIA.

SK5 BLADE
AL CASTING HANDLE



Model #	Description
WP332012	215mm

FORGED BYPASS PRUNER

25mm
1 INCH
MAX DIA.

CR-V FORGED
SOFT-GRIP BI-MATERIAL HANDLE



Model #	Description
WP332013	220mm

PRUNING SNIPS

12mm
1/2 INCH
MAX DIA.

SS STAINLESS STEEL BLADE
SOFT-GRIP BI-MATERIAL HANDLE

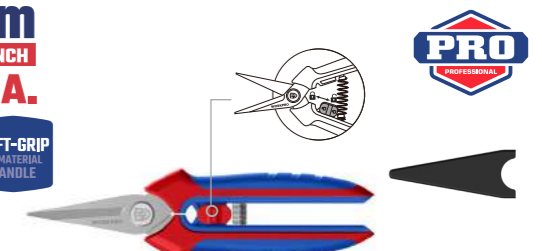

Model #	Description
WP332014	160mm

FOLDING PRUNING SAW

- Ideal for cutting thick branches
- Fully-hardened, precision-ground steel blade stays sharp, even through heavy use
- Blade folds into handle for convenient storage and transport
- Ergonomic ABS and TPE grips



Model #	Description
WP333002	230mm

HAND CULTIVATOR

- Three sharp tines for cultivating, turning and loosening soil
- Rust-resistant die-cast aluminum head



Model #	Description
WP331006	Length: 320mm

HAND FORK

- Ideal for safe planting and transplanting
- Rust-resistant die-cast aluminum head



Model #	Description
WP331007	Length: 317mm

HAND WEEDER

- To pull and remove weeds
- Rust-resistant die-cast aluminum head



Model #	Description
WP331008	Length: 328mm

HAND TROWEL

- To dig plant holes and transplant seedlings
- Rust-resistant die-cast aluminum head
- Thumb depression for comfort
- Ergonomic grip handle
- Easy storage hang hole

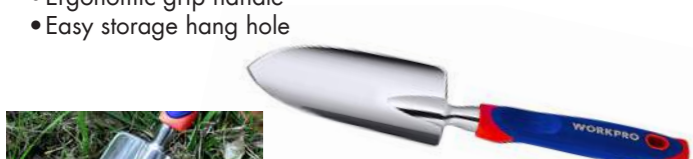

Model #	Description
WP331009	Length: 325mm

TRANSPLANTER TROWEL

- Used for planting seeds and transplanting seedlings into planters and small beds
- Rust-resistant die-cast aluminum head



Model #	Description
WP331010	Length: 325mm

GARDEN SHEARS

- Strong enough to prune hard branches of trees and shrubs
- Easy to use locking mechanism
- Powerful wired spring



Model #	Description
WP332001	Length: 180mm(7")

FLORAL SNIP

- Suitable for cutting flowers
- Full heat treated and sharp blades
- Easy to use locking mechanism



Model #	Description
WP332002	Length: 180mm(7")

ANVIL PRUNER

- Ideal for pruning dry, dead growth
- Full heat treated and sharp blades
- Easy to use locking mechanism



Model #	Description
WP332003	Length: 180mm(7")

PRUNER TOOL SET

- Ideal for pruning flowers and other garden plants
- Full heat treated and sharp blades
- Easy to use locking mechanism



Model #	Description
WP204500	1PC 375mm(15") lopper, 1PC 200mm(8") pruner

MULTI FUNCTION HEDGE SHEARS

- Ideal for cutting, trimming, and shaping live growth such as hedgerows, shrubs, and bushes
- Full heat treated and sharp blades
- Ergonomic design handle



Model #	Description
WP332004	Length: 640mm(25")

BYPASS LOPPER

- Design for trimming live, green growth
- Full heat treated and sharp blades
- Ergonomic design handle



Model #	Description
WP332006	Length: 675mm(27")

TELESCOPING BYPASS LOPPER

- Full heat treated and sharp blades
- Extends to desired length to access hard-to-reach



Model #	Description
WP332007	Extended range: 670-920mm(26-3/8" - 36-3/8")



PERSONAL PROTECTIVE EQUIPMENT

- WORK GLOVES
- SAFETY GOGGLES
- DUST MASK
- EAR PROTECTION
- SAFETY HELMET
- SAFETY SHOES
- REFLECTING JACKET

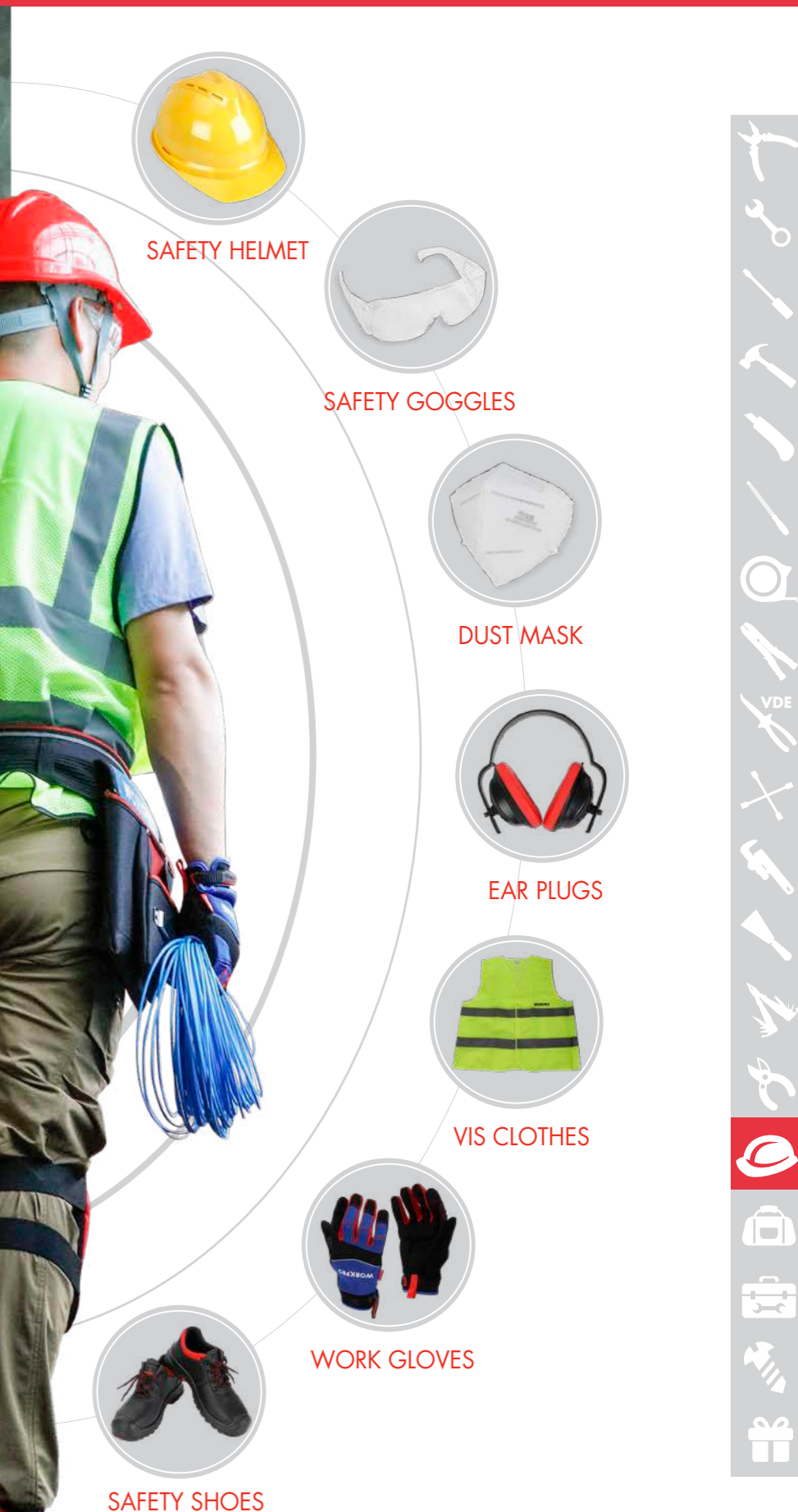

3D MECHANIC GLOVES

IMPACT & VIBRATION REDUCTION

Heavy-duty 3D PVC
Prevent working impact



Digital Touch
Can use telephone at working momentarily



Thickened Palm
PU+SBR+Black Microfiber

Model #	Description
WP371004	L
WP371005	XL

MECHANIC GLOVES

MECHANIC STYLE

Breathable & Abrasion Resistance Material



Digital Touch
Can use telephone at working momentarily



Thickened Palm
Reducing the pressure

Model #	Description
WP371001	L
WP371002	XL

WORKING GLOVES

- Material: Polyester, smooth fabric, no hair and dust, excellent wear resistance
- 10 knitted wrist
- Good air permeability, good elasticity, comfortable to use

12
PAIR



Model #	Description
WP371006	XL

KNITTED & DOTTED PVC GLOVES

- Material: polyester&PVC
- 7 knitted wrist
- Non-slip beads, wear-resistant and breathable

12
PAIR



Model #	Description
WP371007	XL

ANTISTATIC GLOVES

- Nylon fiber and polyurethane material
- PU coating is antistatic
- Eco-friendly, wear-resisting and sweat-absorbing

12
PAIR



Model #	Description
WP371008	XL

TEXTURED LATEX GLOVES

- Material of liner: nylon
- Palm dipped green latex crease, screen printing
- 10 Knitted wrist
- Textured palm dip



Model #	Description
WP371011	XL

CUT RESISTANT GLOVES

- Nitrile butadiene frosted offers grip and abrasion resistance
- HPPE shell, cut-resistance, abrasion and anti-static



Model #	Description
WP371014	XL

RUBBER GLOVES

- Material: Latex
- Protect your hand from detergent or chemicals.
- Anti-slip, anti-stab, anti-tensile, low temperature and high temperature working



Model #	Description
WP371016	XL

NITRILE GLOVES

- Material: nylon, gray nitrile, 13 knitted wrist
- Wear-resistant, skid-resistant, flexible and breathable, flexible cuffs, waterproof oil palm resistant, washable



Model #	Description
WP371010	XL

CUT RESISTANT GLOVES

- Cut resistance level 3 liner with PU coated palm, flexible and good feeling
- HPPE shell, cut-resistance, abrasion and anti-static



Model #	Description
WP371013	XL

HEAVY NITRILE GLOVES

- Material: cotton + nitrile immersion
- 13 Knitted wrist
- Thicker inner bladder



Model #	Description
WP371015	XL

LEATHER GLOVES

- Two-layer skin without inner lining
- Fireproof thread sewing, anti-open thread, wear-resistant
- All leather fireproof flower



Model #	Description
WP371018	XL; Length:24.5-25.4cm

SAFETY GOGGLES

**ANTI-IMPACT
SPLASHING
SAND**

CE

Adjustable Head Belt
Stretchable headband fits your head well

Enough Room
Wear nearsighted glasses when working

Vent Design
Air vents on the frame enhance air circulation

Silicone Bridge
Soft sealing tape and nose pad reduce damage to skin

HD Clear PV Lens
Ensure the vision, prevent distortion of objects



Model #	Description
WP372002	Lens thickness: 1.77mm; Goggles width: 151mm; Lens height:72mm; Weight: 67.40g

SAFETY GOGGLES

- PC lens, PVC temples
- Soft nose bridge frame to fit your face well for comfortable wearing
- Combined with louver-type ventilation design to play a comfortable and breathable effect
- Impact resistance, sand resistance
- Fit to wearing the corrective glasses, also can be used as visitors glasses

CE



Model #	Description
WP372000	Lens thickness: 2.3mm; Goggles width: 165mm; Lens height:55mm; Weight :45.3g

SAFETY GOGGLES

- PC lens, PVC adjustable temples
- Ergonomic integrated lens design is comfortable and stress-free
- High-definition transparency of PVC lens, wide-angle vision
- Anti-dust, anti-pollen and anti-allergic functions.
- Reduce ultraviolet rays and block glare, protect eyes from harmful lights
- Anti-splash function to protect eyes from strong impact

CE



Model #	Description
WP372001	Lens thickness: 2.06mm; Goggles width:146mm; Lens height:55mm; Weight :32.5g



SAFETY GOGGLES

- PC lens, PVC temples
- Made of PVC material
- High impact, scratch resistant impact resistant lenses

CE



Model #	Description
WP372003	Lens thickness: 1.89mm; Goggles width:147mm; Lens height:55mm; Weight :24.7g



ANTI-NOISE EARMUFFS

- ABS shell, PVC cushion, POM headband
- Adjust the head hoop to ensure proper tightness
- Portable size for efficient storage

CE



Model #	Description
WP374001	SNR:25dB



DUST MASK

- FFP2 white folding mask, PP nonwoven
- Three-dimensional cutting technology, more fit the face contour
- Multiple protection, more than 95% filtration barrier harmful substances

CE



Model #	Description
WP373000	20pcs



EARPLUG

- Conforms to ear structure, safe and sanitary
- Made from polyurethane foam, smooth and ultra supple; superior noise reduction effect, let operators keep acute hearing in noise ambient



Model #	Description
WP374000	100pcs

KNEE PADS

- Black TPR plastic cover, block texture, 600D Oxford, EVA lining
- Professional design for comfortable use
- Soft and flexible material gives your knees well protection



Model #	Description
WP377008	Size: 20x23x7cm; Weight: 180g



KNEE PADS

- 600D Oxford, black trim, XPE lining
- Professional design for comfortable use
- Soft and flexible material gives your knees well protection



Model #	Description
WP377009	Weight: 80g





SAFETY HELMET

HIGH STRENGTH EXCELLENT PROTECTION



V-shape Construction

Effectively prevent gravitational impact from different angles



Sweat Band
Anti-allergic and skin-friendly



Four-point Cradle

Provide optimum shock absorption



Vent Design

Cool and breathable, comfortable to wear

ABS Shell

Rugged and lightweight, can hold up to tough impact



Slider Type

To suit most head sizes

Adjustable Chin-strap

For universal adjustment



Model #	Description
WP376001	Red
WP376000	Yellow

Model #	Description
WP376002	Blue
WP376003	White

SAFETY SHOES

SUPER DURABLE



Anti-fatigue Technology Comfort System

Absorbs shock and returns energy back to the foot

Steel Toe

For good protection and superior fit



Electrical Hazard Protection

Fiberglass shank for structural support

PU Upper

Rubber Outsole

Anti-slip, anti-oil, and abrasion-resistant

Model #	Description
WP377000	(EU)38
WP377001	(EU)39
WP377002	(EU)40
WP377003	(EU)41

Model #	Description
WP377004	(EU)42
WP377005	(EU)43
WP377006	(EU)44
WP377007	(EU)45

HIGH VISIBILITY REFLECTING JACKET



- Made of Knitted Fabric, 100% polyester fabric & Reflective Material,
- High Visibility: Yellow Highlight Reflective Strips.
- Multi-function Pockets: 5 front pockets with zipper magic poster clamshell closure, 2 large pockets, 1 PVC transparent ID badge holder, 1 flap pocket and 5 pouch holder for flashlight, laser pointer



Model #	Description
WP378012	Green, M
WP378013	Green, L
WP378015	Orange, M
WP378016	Orange, L

REFLECTING JACKET

- Polyester material, breathable, lightweight and durable.
- 5cm width high reflective tape for safety protection



Model #	Description
WP378000	Green, M
WP378001	Green, L
WP378002	Green, XL
WP378003	Green, XXL
WP378005	Green, XXXL
WP378006	Orange, M
WP378007	Orange, L
WP378008	Orange, XL
WP378009	Orange, XXL
WP378010	Orange, XXXL



STORAGE

SOFT STORAGE
STEEL STORAGE
PLASTIC STORAGE
WORK FACILITATION

ZIP-TOP WIDE MOUTH STORAGE BAG

**SUPER SELECTED
STURDY BOTTOM**



Sturdy Bottom



Model #	Description
WP281003	300x180x200mm
WP281004	350x190x220mm
WP281005	460x215x245mm

WIDE MOUTH STORAGE BAG WITH WATER PROOF MOLDED BASE

**WATERPROOF
AND DURABLE**



Model #	Description
WP281007	420x230x270mm
WP281026	510x260x290mm

WIDE MOUTH STORAGE BAG

- 500D polyester material
- Multi-pocket design
- Convenient, durable and easy to carry



Model #	Description
WP281001	320x210x230mm

Model #	Description
WP281002	445x290x320mm

TOOL BAG WITH TUBULAR STEEL HANDLE

COLLAPSIBLE AND DURABLE

- Open-top design for easy access to contents
- Reinforced handle protector for comfortable and maximum durability
- Multi-components storage case included for hardware storage
- Outer mesh pocket stores personal belongings, small tools & accessories
- 14 Multi-use pockets inside, and 8 outside organize tools and accessories
- 600D polyester material



Model #	Description
WP281006	390x220x290mm

FOLDABLE TOOL BAG

- Material: 600D polyester
- Various pockets for tools
- Sturdy top handle



Model #	Description
WP281011	410x235x270mm(16")

MULTIFUNCTIONAL BELT

- Material: 600D polyester
- Various pockets for tools
- Durable, easy to carry



Model #	Description
WP281014	300x210mm(11-4/5")

TOOL POUCH

- Material: 600D polyester
- Various pockets for tools



Model #	Description
WP281017	260x300mm

HAMMER LOOP

- Material: 600D polyester
- Black nickel-plated metal loop for durability
- With magnetic stripe



Model #	Description
WP281012	195x125mm(5")

ELECTRICIAN POUCH

- Material: 600D polyester
- Various pockets for tools
- Durable, easy to carry



Model #	Description
WP281015	290x270mm(11-2/5")

HEAVY DUTY ROLLING TOOL BAG

- Reinforced 1680D polyester
- Heavy-duty zipper
- Internal pockets
- Front Velcro pockets
- Twin carry handles with Velcro grip
- Strong trolley handle
- With removable inserter



Model #	Description
WP281019	500x300x400mm(18")

MAGNETIC TOOL HOLDER

ORGANIZATION OF SMALL HARDWARE

Strong Magnetic
Keep tools in place



1680D Polyester



Model #	Description
WP289001	384x90mm, L
WP289002	285x75mm, S

MAGNETIC TOOL HOLDER

QUICK AND EASY ACCESS

Strong Magnetic
Keep tools in place

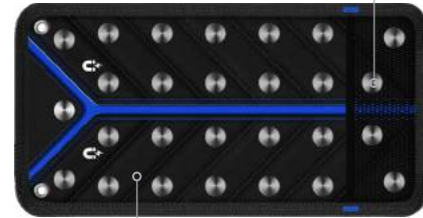

1680D Polyester



Model #	Description
WP289003	300x155mm

POLYESTER WORK APRON

- Polyester fabric
- Multi-pocket design
- Convenient and adjustable



Model #	Description
WP289006	686x864mm



5-TRAY CANTILEVER TOOLBOX

- All-metal with anti-rust powder coating
- With great hardness, durability, and high load-bearing capacity
- 4 metal connectors on both sides connect the 5 foldable trays
- Convenient for use with the retractable design



3-TRAY CANTILEVER TOOLBOX

- All-metal with anti-rust powder coating
- With great hardness, durability, and high load-bearing capacity
- 4 metal connectors on both sides connect the 3 foldable trays
- Convenient for use with the retractable design



Model #	Description
WP282001	Size: 495x200x290mm; Steel thickness: 0.8mm
WP282002	Size: 400x200x195mm; Steel thickness: 0.8mm

Model #	Description
WP282003	Size: 420x200x170mm; Steel thickness: 0.8mm
WP282004	Size: 340x170x200mm; Steel thickness: 0.8mm

3-DRAWER TOOLBOX

EASY ORGANIZATION WITH DRAWERS



Model #	Description
WP282006	510x265x350mm

2-DRAWER TOOLBOX

- Steel thickness: 0.6-0.8mm
- 2 drawers design
- Pull handle + recessed handle
- All-metal structure is more durable



Model #	Description
WP282005	460x240x220mm

3-LAYER TOOL CART

- All-iron construction
- Surface baking finish, wear-resistant
- 3-layer pallet, larger storage space
- Brake system can lock the casters firmly



Model #	Description
WP285001	840x410x660mm

7-DRAWER ROLLER CABINET

MORE DRAWERS LARGER SPACE



Model #	Description
WP285002	976x766x480mm



HEAVY DUTY TOOLBOX

VERSATILE TOOL ORGANIZER



Model #	Description
WP283001	410x230x205mm
WP283002	507x254x259mm
WP283003	572x300x295mm

HEAVY DUTY WATERPROOF SAFE CASE

- Ultra high impact plastic
- IPx5 water-proof
- Shock-proof



Model #	Description
WP283004	460x360x175mm

STACKABLE AND INTERLOCK PARTS ORGANIZER

- Transparent PP material
- Convenient, durable and easy to carry
- Multiple stackable and interlocking structure
- Removable dividers



Model #	Description
WP283007	385x300x75mm

38-DRAWER PLASTIC PARTS ORGANIZER

- Transparent PP material
- Convenient, durable and easy to carry
- Suitable for storage and organization of small hardware, etc.



Model #	Description
WP283009	520x160x375mm; 38 drawers

PLASTIC PARTS ORGANIZER WITH DRAWERS

- Transparent PP material
- Convenient, durable and easy to carry
- Suitable for storage and organization of small hardware, etc.



Model #	Description
WP283010	39 drawers; 475x380x160mm
WP283011	18 drawers; 475x380x160mm

STACKABLE AND INTERLOCK PARTS ORGANIZER

- Transparent PP material
- Stackable interlocking structure
- Suitable for daily storage and organization



Interlock Horizontally & Vertically



Model #	Description
WP283012	2 drawers; 295x195x160mm
WP283013	4 drawers; 295x195x160mm
WP283014	12 drawers; 295x195x160mm

COMPARTMENT BOX

- Transparent PP material
- Durable and easy to carry
- Removable dividers



Model #	Description
WP283005	10 grids; 134x75x24mm
WP283006	18 grids; 123x127x35mm

PORTABLE WORKBENCH

- Printed with grid, ruler, and protractor
- Folding design for compact storage
- MDF board
- Accommodates a wide variety of woodworking projects



PORTABLE WORKBENCH

- Dual-height, adjustable legs
- Folding design for compact storage
- Bamboo work surface



Model #	Description
WP289026	Expansion size: 620x560x755mm; Safe working load: 70kg

Model #	Description
WP289027	Expansion size: 605x715x (210-770)mm; Safe working load: 100kg

4-IN-1 MULTI-FUNCTION FOLDING WORKBENCH

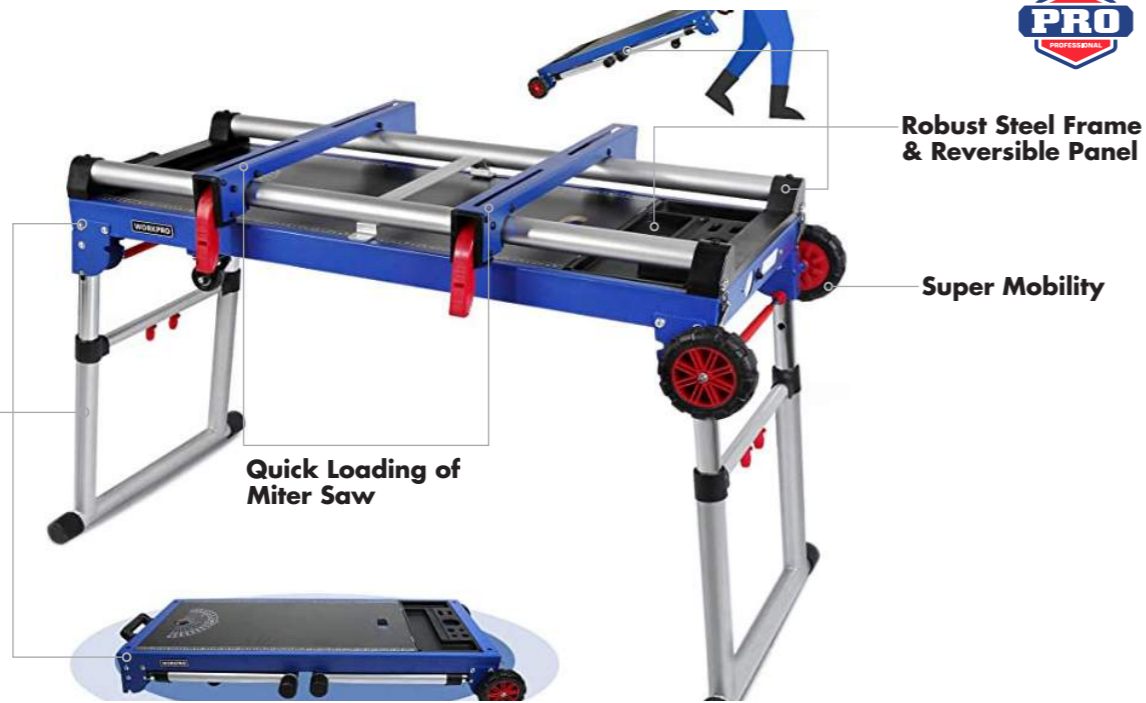

Model #	Description
WP289020	Expansion size: 107x4x56/66.5/76cm; Max. size after folding: 121.5x59x24cm

HEAVY DUTY FOLDING ADJUSTABLE SAWHORSE

Release Button Ergonomic Grip Handle Anti-slip Work Surface



Material Support Pegs

Load Capacity: 480 lb

2x4 Material Slots

Drop your boards in each slot to connect two sawhorses



Model #	Description
WP289019	Expansion size: 107x(46.4-61.5)x(65-82.2)cm



TOOL SETS

- HOME REPAIR TOOL SET
- SOCKET SET
- MECHANICS TOOL SET
- LADY TOOL SET
- KID TOOL SET

193PC 7-DRAWER ROLLER CABINET TOOL SET

BASIC CONFIGURATION



WP209038



WP209041

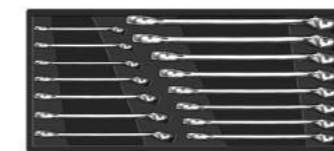

WP209043



WP209047



WP209048

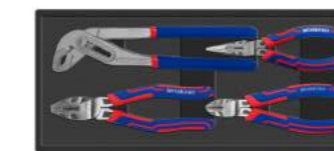

WP209052



BONUS



FREE COMBINATION



STACKABLE DESIGN



Model #	Configuration	Description
WP209074	WP285002	7-DRAWER ROLLER CABINET
	WP209038	50PC 1/4\"/>
	WP209041	24PC 1/2\"/>
	WP209043	15PC COMBINATION WRENCH SET
	WP209047	8PC SCREWDRIVER SET
	WP209048	31PC TOOL SET
	WP209052	4PC PLIERS SET



50PC 1/4"DR. SOCKET TOOL SET

- 1pc 1/4" ratchet wrench (72T)
- 13pcs 1/4" Hex sockets: 4mm, 4.5mm, 5mm, 5.5mm, 6mm, 7mm, 8mm, 9mm, 10mm, 11mm, 12mm, 13mm, 14mm
- 5pcs 1/4" Star sockets: 4mm, 5mm, 6mm, 7mm, 8mm
- 18pcs 1/4" Bits sockets: H2, H3, H4, H5, H6, T10, T15, T20, T25, T30, SL4, SL5.5, SL7, PH1, PH2, PH3, PZ1, PZ2
- 7pcs 1/4" Deep sockets: 4mm, 5mm, 6mm, 7mm, 8mm, 9mm, 10mm
- 2pcs 1/4" Extension bars: 50mm, 100mm
- 1pc 1/4" Spinner handle, 150mm
- 1pc 1/4" Universal joint
- 1pc 1/4" Sliding T-bar
- 1PC 1/4" bit adaptor



Model #	Description
WP209038	50pcs

23PC 3/8"DR. SOCKET TOOL SET

- 1pc 3/8" Ratchet wrench 72T
- 10pcs 3/8" Hex sockets: 10, 11, 12, 13, 14, 15, 16, 17, 18, 19mm
- 6pcs 3/8" Deep sockets: 10, 11, 12, 13, 14, 15mm
- 2pcs 3/8" Extension bars: 75mm, 150mm
- 2pcs 3/8" Spark plug sockets: 16mm, 21mm
- 1pc 3 way adapter 1/2" F-3/8" M
- 1pc 3/8" Universal joint



Model #	Description
WP209040	23pcs

24PC 1/2"DR. SOCKET TOOL SET

- 1pc 1/2" Ratchet wrench 72T
- 17pcs 1/2" Hex sockets: 10, 11, 12, 13, 14, 15, 16, 17, 18, 19, 20, 21, 22, 24, 27, 30, 32mm
- 2pcs 1/2" Extension bars: 125mm, 250mm
- 2pcs 1/2" Spark plug sockets: 16mm, 21mm
- 1pc 1/2" Universal joint
- 1pc 3 way adapter 1/2"



Model #	Description
WP209041	24pcs

31PC TOOL SET

- 9pcs Cr-V long arm hex key set: 1.5, 2, 2.5, 3, 4, 5, 6, 8, 10mm
- 9pcs Cr-V long arm torx key set: T10, T15, T20, T25, T27, T30, T40, T45, T50
- 1pc 200mm adjustable wrench
- 1pc 5mx19mm tape measure
- 1pc 18mm plastic snap-off knife
- 10pcs 18mm snap-off blades in one storage



Model #	Description
WP209048	31pcs

5PC 200MM FILE SET

- 1pc square file with tri-color handle
- 1pc round file with tri-color handle
- 1pc triangular file with tri-color handle
- 1pc half round file with tri-color handle
- 1pc flat file with tri-color handle

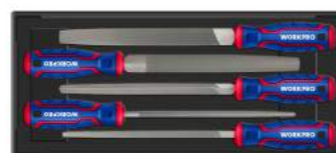

Model #	Description
WP209049	5pcs

11PC DOUBLE OPEN WRENCH SET

- 11pcs Cr-V wrenches: 6x7, 8x9, 10x11, 12x13, 14x15, 16x17, 18x19, 20x22, 21x23, 24x27, 30x32mm



Model #	Description
WP209045	11pcs

15PC COMBINATION WRENCH SET

- 15pcs Cr-V wrenches: 7, 8, 9, 10, 11, 12, 13, 14, 15, 16, 17, 18, 19, 21, 22mm

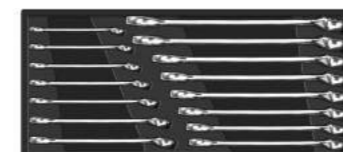

Model #	Description
WP209043	15pcs

4PC PLIERS SET

- 1pc 160mm(6") CR-V long nose pliers
- 1pc 160mm(6") CR-V diagonal pliers
- 1pc 200mm(8") CR-V combination pliers
- 1pc 250mm(10") CR-V groove joint pliers

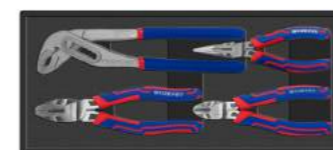

Model #	Description
WP209052	4pcs

8PC SCREWDRIVER SET

- 4pcs Cr-V Phillips screwdriver: PH0x75mm, PH1x100mm, PH2x100mm, PH3x150mm
- 4pcs Cr-V Slotted screwdriver: 3x75mm, 5.5x100mm, 6.5x100mm, 8x150mm

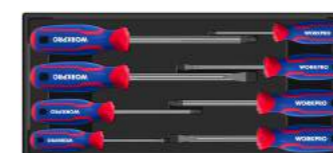

Model #	Description
WP209047	8pcs

8PC DOUBLE RING WRENCH SET

- 8pcs Cr-V steel: 6x7, 8x9, 10x11, 12x13, 14x15, 16x17, 18x19, 20x22mm

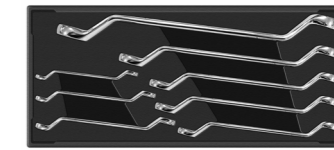

Model #	Description
WP209044	8pcs

3PC PLIERS SET

- 1pc 180mm(7") CR-V curved jaw locking pliers
- 1pc 250mm(10") CR-V curved jaw locking pliers
- 1pc 230mm(9") CR-V long nose straight jaw locking pliers

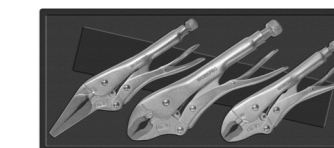

Model #	Description
WP209050	3pcs

4PC CIRCLIP PLIERS SET

- 1pc 180mm(7") straight external circlip pliers
- 1pc 180mm(7") bent external circlip pliers
- 1pc 180mm(7") straight internal circlip pliers
- 1pc 180mm(7") bent internal circlip pliers

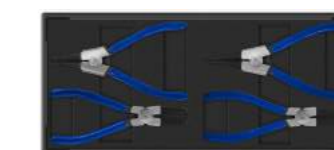

Model #	Description
WP209051	4pcs

5PC STRIKING TOOL SET

- 1pc 40mm fiberglass double face hammer
- 1pc 300g machinist's hammer
- 1pc 13mm chisel
- 1pc 2mm nail punch
- 1pc 6mm center punch



Model #	Description
WP209053	5pcs

195PC CABINET TOOL SET - EVA TRAY

- 1pc WORKPRO 7- drawer roller cabinet
- 1pc Mechanic Work Gloves - XL

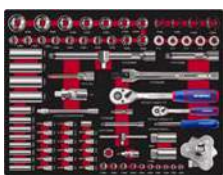

DRAWER 1

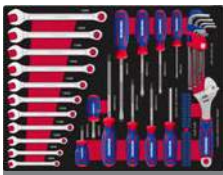

DRAWER 2



DRAWER 3

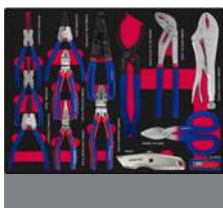

BONUS



Model #	Description
WP209037	195pcs

DRAWER 1

- 1pc 1/4" Dr. ratchet handle (72T)
- 10pcs 1/4" Dr. standard socket 6PT: 4mm, 5mm, 6mm, 7mm, 8mm, 9mm, 10mm, 11mm, 12mm, 13mm
- 17pcs 1/4" Dr. bits sockets: H3, H4, H5, H6, T10, T15, T20, T25, T30, SL4, SL5.5, SL7, PH1, PH2, PH3, PZ1, PZ2
- 8pc 1/4" Dr. deep sockets (50mm): 6mm, 7mm, 8mm, 9mm, 10mm, 11mm, 12mm, 13mm
- 2pc 1/4" Dr. extension bars: 50mm, 100mm
- 1pc 1/4" Dr. spinner handle, 150mm
- 1pc 1/4" Dr. flexible extension bar, 150mm
- 1pc 1/4" Dr. universal joint
- 1pc 1/4" Dr. sliding T-bar
- 1pc 1/4" Dr. bit adaptor
- 1pc 1/2" Dr. ratchet wrench
- 17pcs 1/2" Dr. standard socket 6PT: 10mm, 11mm, 12mm, 13mm, 14mm, 15mm, 16mm, 17mm, 18mm, 19mm, 20mm, 21mm, 22mm, 24mm, 27mm, 30mm, 32mm
- 4pcs 1/2" Dr. deep sockets: 14mm, 15mm, 17mm, 19mm
- 5pcs 1/2" Dr. E sockets: E10, E12, E14, E16, E20
- 1pc 1/2" Dr. universal joint
- 2pcs 1/2" Dr. extension bars: 125mm, 250mm
- 1pc 1/2" Dr. CR-V 3 way adapter
- 2pcs 1/2" Dr. spark plug sockets: 16mm, 21mm
- 4pcs Impact sockets: 17, 19, 21, 23mm
- 1pc pin wrench socket
- 1pc oil filter wrench
- 1pc CR-V 12.5mm socket for cover of cylinder T52X100L
- 1pc 1/2"x250mm F-Shape breaker bar

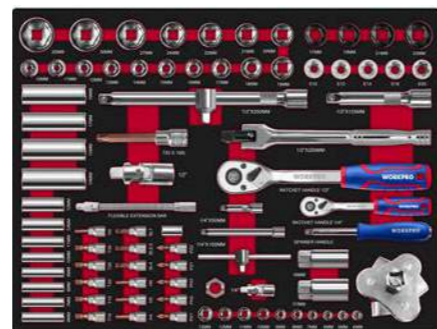

DRAWER 2

- 11 pcs CR-V combination wrench: 8, 9, 10, 11, 12, 13, 14, 16, 17, 18, 19mm
- 9 pcs screwdriver, CR-V, chrome-plated: SL3x75mm, 5.5x100mm, 6.5x150mm, 8x150mm, 6.5x38mm; PH1x100mm, 2x150mm, 3x150mm, 2X38mm
- 1pc Magnetic bit holder 10x75mm
- 40pcS 25mm CR-V bits, sand blasted with bit holder: A:PH0,PH1,PH2x3,PH3,H3,H4,H5,H6 ; B:SL3,4,5,6,7,T10,T15,T20,T25,AD; C:PH1,PH2x4,PH3,PZ0,PZ1,PZ2,PZ3 ; D:S0x2,S1x2,S2x4,S3x2
- 9pcs Cr-v long hex key set: 1.5, 2, 2.5, 3, 4, 5, 6, 8, 10mm
- 1pc 200mm(8") CR-V adjustable wrench with Tri-color Handle

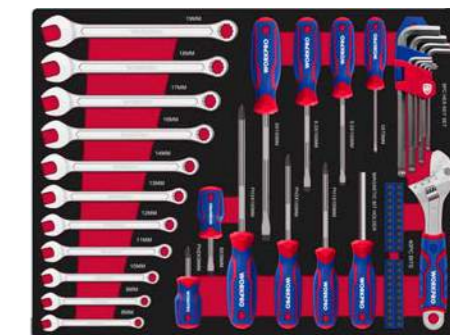

DRAWER 3

- 5pcs 200mm(8") Files with tri-color handle: square file, round file, triangular file, half round file, flat file
- 1pc Telescoping inspection mirror(720mm)
- 1pc 40mm Fiberglass double face hammer
- 1pc 5Mx19mm Tape measure
- 1pc 300g Machinist's hammer
- 1pc 13mm Chisel
- 1pc 2mm Nail punch
- 1pc 6mm Center punch
- 1pc Magnetic pick up tool
- 1pc worklight
- 1pc 150mm(6") saw



DRAWER 4

- 4pcs CR-V 180mm(7") Circlip pliers
- 1pc 150mm(6") CR-V long nose pliers
- 1pc 150mm(6") CR-V diagonal pliers
- 1pc 200mm(8") CR-V Combination pliers
- 1pc 200mm(8") wire stripper
- 1pc 300mm(12") oil filter pliers
- 1pc 250mm(10") CR-V groove joint pliers
- 1pc 250mm(10") CR-V locking pliers
- 1pc 180mm(7") tin snip
- 1pc utility knife
- 10pc utility knife blades





4PC PLIERS AND WRENCH SET

- Drop forged steel
- Bi-material comfort grip handle
- 160mm(6") long nose pliers
- 160mm(6") diagonal pliers
- 160mm(6") combination pliers
- 160mm(6") adjustable wrench



Model #	Description
WP201009	4PC

5PC PLIERS AND WRENCH SET

- 200mm(8") long nose pliers
- 180mm(7") diagonal pliers
- 200mm(8") combination pliers
- 250mm(10") groove joint pliers
- 200mm(8") adjustable wrench



Model #	Description
WP201010	5PC

8PC HOME REPAIR TOOL SET

- 1pc 18mm snap-off knife
- 2pc screwdriver: 6X100mm, PH2X100mm
- 1pc 160mm(6") combination pliers
- 1pc 8oz(225g) curved claw hammer, stubby
- 1pc 3m(12ft.) tape measure
- 1pc 0.18mmx1.9cmx9m insulated tape
- 1pc circuit tester



Model #	Description
WP209001	8PC

32PC HOUSEHOLD TOOL KIT

- 1pc 6" long nose pliers, carbon steel, double injection handle
- 1pc 6" diagonal pliers, carbon steel, double injection handle
- 1pc 6" adjustable wrench, carbon steel with chrome-plated
- 1pc 5-1/2" scissors, stainless steel blade
- 1pc 18mm snap-off knife
- 3pcs 18mm snap-off knife handles in plastic box
- 1pc 8oz fibreglass handle claw hammer
- 1pc 3m tape measure
- 2pcs screwdrivers, CR-V blade, chrome-plated: PH1x100, 3x75
- 1pc magnetic bit driver
- 20pcs 1" CR-V bits, size: PH0,PH1,PH2X3,PH3,H3,H4,H5,H6; SL3,4,5,6,7,T10,T15,T20,T25,AD

- 1pc 9" torpedo level
- 1pc blow mold case



Model #	Description
WP209023	32pcs

170PC TOOL SET

- 1pc 160mm long nose pliers, carbon steel
- 1pc 160mm diagonal pliers, carbon steel
- 1pc 160mm combination pliers, carbon steel
- 1pc 8OZ(225G) tubular handle claw hammer
- 1pc 3m(10ft) tape measure
- 1pc magnetic screwdriver handle
- 40pcs bits, chrome-vanadium
- 1pc 18mm knife
- 3pc 18mm knife blades in plastic box
- 1pc 9" torpedo level
- 8pc hex set
- 50 plugs and 50 screws (6mm)
- 6pcs precision screwdrivers

- 5pcs open-end wrench :8X9,10X11, 12X13, 14X15, 16X17mm



Model #	Description
WP209000	170pcs

100PC TOOL SET

- 9pcs socket with holder:5,6,7,8,9,10,11,12 and 13mm
- 1pc 6"(150mm) combination pliers
- 1pc 6"(150mm) long nose pliers
- 1pc 8"(200mm) adjustable wrench
- 1pc 227g(8oz) claw hammer
- 4pc precision screwdrivers
- 1pc 3m tape measure[MID]
- 1pc utility knife
- 10pcs spare utility knife blades
- 1pc torpedo level 228mm
- 8pcs hex key set
- 1pc bit driver handle
- 20pcs bit set with adaptor(metric)

- 40pcs cable ties
- 1pc tool bag



Model #	Description
WP209066	100pcs

18PC TOOL SET

- 1pc 6" combination pliers, carbon steel, double injection handle
- 1pc 8" adjustable wrench, carbon steel with chrome-plated
- 1pc 5-1/2" scissors, stainless steel blade
- 1pc 9 mm snap-off knife
- 1pc 8oz(227g) curved claw hammer, stubby
- 1pc 3m/10FT tape measure
- 1pc:magnetic bit driver
- 10pcs 1" CR-V bits, size: SL3,5,6,PH1,PH2,PH3,T15,T20, H5,H6
- 1pc circuit tester
- 1pc zipper bag



Model #	Description
WP209059	18pcs

125PC 3-DRAWER HOME TOOL SET

- 8PC metric hex keys
- 8PC SAE hex keys
- 1PC 3/8"DR. ratchet handle
- 1PC 3/8"DR. x3" extension bar
- 1PC 3/8"DR. x 5/8" spark plug socket
- 1PC 3/8"female x 1/4" male adapter
- 9PC 1/4"DR. 6 pt. SAE sockets
- 12PC 3/8"DR. 6 pt. sockets (SAE and mm)
- 1pc 160mm(6") adjustable wrench
- 1pc 160mm(6") long nose pliers
- 1pc 160mm(6") diagonal pliers
- 1pc 160mm(6") slip joint pliers
- 1PC magnetic bit driver
- 19PC 1"bits
- 1PC retractable utility knife
- 10PC knife blades with plastic case
- 1PC 8 oz. claw hammer
- 1PC 12 Ft. tape measure
- 1pc 225mm(9") magnetic torpedo level (3 vials)
- 2pc stubby screwdrivers:6.5x38, PH2 x 38mm
- 1pc 140mm(5-1/2") scissors
- 1pc 19mm (3/4")x 30Ft. electrical tape
- 1PC 9mm snap-off knife
- 40PC cable ties



Model #	Description
WP209028	125PC

165PC HOME REPAIRING TOOL SET

- 13PC 1/4"DR. Socket Metric 6PT: 4, 4.5, 5, 5.5, 6, 6.5, 7, 8, 9, 10, 11, 12, 13mm
- 13PC 1/4"DR. Socket SAE 6PT: 5/32", 3/16", 7/32", 1/4", 9/32", 5/16", 11/32", 3/8", 13/32", 7/16", 15/32", 1/2", 17/32"
- 3PC 1/4" DR. Socket SAE Octagon: 1/4", 5/16", 3/8"
- 2PC 3/8" DR. Socket Metric 6PT: 14, 16mm
- 2PC 3/8" DR. Socket SAE 6PT: 9/16", 5/8"
- 1PC 3/8x75mm extension bar
- 1PC 3/8"x1/4" adaptor
- 33PC Bits: 4x3,5,6,7,PH0,PH1,PZ1,PZ2,PZ3; S1,S2X2,S3,T10,T15,T20,T25,T27,T30,T40; 2.5,3,4,5,5.5,6mm, PH2x4, PH3
- 22PC Hex key: Metric: 1.27, 1.5, 2, 2.5, 3, 3.5, 4, 4.5, 5, 5.5, 6, 0.05; SAE: 1/16", 5/64", 3/32", 7/64", 1/8", 9/64", 5/32", 3/16", 7/32", 1/4"
- 1PC magnetic bit holder
- 58PC hardwares
- 1PC measuring tape 3M/10FT
- 1PC 7oz claw hammer with wooden handle
- 1PC 160mm(6") Long Nose Pliers
- 1PC 160mm(6") Adjustable Wrench

- 5PC Combination Wrench:6,8,10,11,12mm
- 6PC precision screwdriver: SL1.4, 2.0, 2.4, 3.0; PH0, PH1
- 1PC 3/8"DR. ratchet handle
- 1PC BMC

MM
SAE



Model #	Description
WP209022	165PC

129PC HOME REPAIRING TOOL SET

- 1pc 16" zip-top tool bag
- 1pc 9" plastic torpedo level
- 9pcs metric hex key set
- 1pc magnetic bit holder
- 40pcs 1" CR-V bits
- 6pcs nut drivers
- 1pc 3m tape measure
- 1pc 6" mini saw
- 1pc 7" curved jaw locking pliers
- 1pc 16oz claw hammer
- 1pc 7" diagonal pliers
- 1pc 8" long nose pliers
- 1pc 8" adjustable wrench
- 1pc 8" groove-joint pliers
- 6pcs combination wrench: 6, 8, 10, 11, 13, 14mm
- 6pcs precision screwdriver: PH000, PH00, PH0, SL1.5, 2, 3mm
- 1pc aluminum quick-change utility knife
- 10pcs SK5 utility knife blades with heavy duty box
- 40pcs cable ties

129
PIECE



Model #	Description
WP209061	129pcs

156PC HOME REPAIRING TOOL SET

- 1PC 16" zip-top tool bag
- 1PC 9" plastic torpedo level
- 8PC metric hex key set
- 8PC SAE hex key set
- 1PC magnetic bit holder
- 60pc 25mm(1") CR-V bits
- 6PC nut drivers
- 1PC 3 metre tape measure
- 1pc 150mm(6") mini saw
- 1pc 180mm(7") curved jaw locking pliers
- 1pc 190mm(7-1/2") diagonal pliers
- 1pc 200mm(8") long nose pliers
- 1pc 200mm(8") adjustable wrench
- 1pc 200mm(8") groove-joint pliers
- 6PC combination wrench with clip
- 6PC precision screwdriver set
- 1PC utility knife
- 10PC utility knife blade set in plastic box

- 40PC cable ties
- 1PC 16oz tubular claw hammer

156 PIECE **CR-V** STEEL **MM** SAE



Model #	Description
WP209010	156PC

297PC TOOL KIT WITH ALUMINUM CASE

- 1PC utility knife
- 1PC 18mm snap off knife
- 3PC 18mm snap off knife blade
- 1PC 180mm combination pliers
- 1PC diagonal cutting pliers
- 1PC long nose pliers
- 1PC adjustable wrench
- 1PC 240mm box joint pliers
- 1PC steel flat file 200mm
- 1PC 200mm crimping tool
- 1PC voltage tester 100-250V
- 1PC 3/8" ratchet handle
- 1PC 1/4" 110mm sliding T bar
- 1PC 3/8" 150mm extension bar
- 1PC sliding adaptor
- 1PC 3/8" spark Socket 21mm
- 1PC 3/8" to 1/4" socket adaptor
- 1PC 1/4" bit adaptor CR-V
- 8PC 1/4" DR.Socket CR-V: 4, 4.5, 5, 5.5, 6, 7, 8, 9mm
- 9PC 3/8" DR.Socket CR-V: 10, 11, 12, 13, 14, 15, 17, 18, 19mm
- 6PC screwdriver: 6x150mm, 5x100mm, 1.5x50mm, PH1x100mm, PH2x150mm, PH0x50mm
- 1PC 1/4" bit driver, CR-V
- 31PC bits with case
- 1PC hacksaw
- 1PC 250mm hacksaw blade. 24TPI.
- 9PC hex key set: 1.5, 2, 2.5, 3, 4.5, 6, 8, 10mm
- 1PC 225mm plastic torpedo level

- 8PC combination wrench: 8, 10, 11, 12, 13, 14, 17, 19 mm
- 100PC Hardware assortment
- 1PC Insulation tape
- 60PC 3.6x200mm cable ties
- 40PC 3.6x200mm cable ties
- 1PC 300g mechanic hammer
- 1PC 5m tape measure
- 1PC aluminium tool box



297 PIECE **CR-V** STEEL **MM**



Model #	Description
WP209031	297PC

101PC 12V CORDLESS DRILL AND HOME TOOL SET

- 1pc 12V cordless lithium-ion drill driver
- Lithium-ion battery: 12V 1.5Ah.Torque: 20NM.Speed:0-400/0-1500RPM.
- Charging time: 3-5Hrs
- 10pcs HSS4241 drill bits: 1/16, 5/64, 3/32, 7/64, 1/8, 9/64, 5/32, 11/64, 3/16, 1/4
- 32pcs screwdriver bits set
- 1pc 12oz Fiberglass handle hammer
- 1pc 225mm(9") torpedo level
- 2pcs 160mm(6") Adjustable wrench
- 1pc 6" long nose pliers
- 1pc Screwdriver holder
- 1pc 3M/10FT tape measure
- 1pc 18 mm snap off knife
- 10pcs Knife blades
- 32pcs Hardware kit
- 8pcs hex key set: 1/16, 5/64, 3/32, 1/8, 5/32, 3/16,7/32, 1/4
- 1 pc 13" Storage bag



Model #	Description
WP209069	101pcs

29PC 3.7V PIVOTING SCREWDRIVER AND TOOL SET

- 1pc 3.7v Li-ion Rechargeable Screwdriver with Adjustable two-position handle
- Lithium-ion battery: 3.7V 1500mAh.TORQUE: 4NM. Speed:235RPM.
- Charging time: 2-3Hrs
- 9pcs CR-V bits: PH 0-1-2,PZ 1-2,T 15- 20,SL 5,H 4+ 1pcs 50mm extension bar
- 1pc 8oz Fiberglass Claw Hammer
- 1pc 225mm(9") Torpedo level
- 1pc 160mm(6") Adjustable wrench
- 1pc 3M/10FT tape measure
- 1pc 18 mm snap off knife
- 10pcs Knife blades
- 1pc 8-1/2" scissors
- 8pcs 6" long nose pliers



Model #	Description
WP209070	29pcs

26PC MOTORCYCLE REPAIR TOOL SET

- 9pcs Extension Bar: 6, 7, 8, 9, 10, 11, 12, 13, 14mm
- 9pcs 1/4" Bits Socket: H4, H5, H6, SL4, SL5, SL7, PH1, PH2, PH3
- 1pc double function screwdriver handle
- 1pc extra long 10mm 1/4" extension bar
- 5pcs L-shaped wrench: 8, 10, 12, 13, 14mm



MM

Model #	Description
WP204003	26pcs

10PC MOTORCYCLE REPAIR TOOL SET

- 9pcs extension bar: 8, 9, 10, 11, 12, 13, 14, 17, 19mm
- 1pc 1/4" slide T bar



MM



Model #	Description
WP204004	10pcs

13PC MOTORCYCLE REPAIR TOOL SET

- 11pcs 1/2" sockets: 8, 9, 10, 11, 12, 13, 14, 15, 16, 17, 19mm
- 1pc 200mm spinner handle
- 1pc 254mm 1/2" hole joint



MM



Model #	Description
WP202563	13pcs



14PC 1/4" DRIVE SOCKET SET

- CR-V socket set
- 12PC 1/4" DR. sockets: 4, 4.5, 5, 5.5, 6, 7, 8, 9, 10, 11, 12, 13mm
- 1PC 1/4" Dr. x75mm(3") extension bar
- 1PC 1/4" DR. ratchet handle



MM 1/4" DRIVE CR-V STEEL



Model #	Description
WP202556	14PC

12PC 3/8" DRIVE SOCKET SET

- CR-V socket set
- 10PC 3/8" DR. sockets: 10, 11, 12, 13, 14, 15, 17, 19, 21, 22mm
- 1PC 3/8" Dr. x 75mm extension bar
- 1PC 3/8" DR. ratchet handle



MM 3/8" DRIVE CR-V STEEL



Model #	Description
WP202557	12PC

12PC 1/2" DRIVE SOCKET SET

- CR-V socket set
- 10PC 1/2" DR. sockets: 10, 11, 12, 13, 14, 15, 17, 19, 21, 22mm
- 1PC 1/2" Dr. x125mm(5") extension bar
- 1PC 1/2" DR. ratchet handle



MM 1/2" DRIVE CR-V STEEL



Model #	Description
WP202558	12PC

19PC SOCKET SET

- 1PC 3/8"DR. quick release ratchet handle 72T
- 9PC 3/8"DR. SAE socket, 6PT: 1/4", 5/16", 3/8", 7/16", 1/2", 9/16", 3/4", 11/16", 5/8"
- 9PC 3/8"DR. Metric socket, 6PT: 8, 9, 10, 11, 13, 14, 16, 17, 18mm



MM SAE 3/8" DRIVE CR-V STEEL



Model #	Description
WP202552	19PC

10PC DUAL-DRIVE RATCHET SET WITH CR-V SOCKET

- Ergonomic handle with slip-resistant rubber grip
- Patented Dual-drive technology 2x faster than standard ratcheting
- Hold the ratchet ring to engage Dual-drive
- Rotate the handle only to work as standard ratchet
- At the starting point, directly rotate the ratchet ring can faster work
- 9PC 3/8" Dr.sockets:8,10,11,12,14,16,17,19,20mm



Model #	Description
WP202559	10PC

24PC 3/8" DR. SPEED DRIVER WRENCH & SOCKET SET

- CR-V Steel
- Chrome plated, Mirror polished
- 1PC 3/8"DR. Quick release ratchet handle 72T
- 1PC 3/8"DR. Speed spin T-handle
- 11PC 3/8"DR. 6PT Metric Sockets: 8, 9, 10, 11, 12, 13, 14, 15, 17, 19, 21mm
- 11PC 3/8"DR. 6PT SAE Socket: 1/4", 9/32", 5/16", 3/8", 7/16", 1/2", 9/16", 5/8", 11/16", 3/4", 13/16"



SPEED SPIN



EXTENSION BAR



HIGH TORQUE



Model #	Description
WP202553	24PC

20PC 3/8" DRIVE TOOL SET WITH ROTATING PLASTIC RACK

- 1PC 3/8"DR. 72T quick release ratchet handle
- 9PC 3/8"DR. SAE socket, 6PT: 1/4", 5/16", 3/8", 7/16", 1/2", 9/16", 3/4", 11/16", 5/8"
- 9PC 3/8"DR. METRIC socket, 6PT: 8, 9, 10, 11, 13, 14, 16, 17, 18mm
- 1PC 3/8"x75mm(3") extension bar

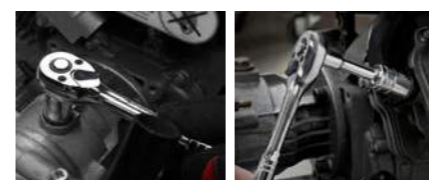

Model #	Description
WP202554	20PC

23PC 1/4"+ 3/8"DR. SOCKET SET WITH ROTATABLE RACK

- CR-V steel
- Chrome plated, mirror polished
- 1PC 3/8"DR. Quick release ratchet handle 72T
- 11PC 1/4"DR. 6PT Metric Sockets: 4, 5, 6, 7, 8, 9, 10, 11, 12, 13, 14mm
- 9PC 3/8"DR. 6PT Metric Sockets: 10, 11, 12, 13, 14, 15, 16, 17, 19mm
- 1PC 3/8"x1/4" adaptor
- 1PC 3/8"x75mm(3") extension bar



Model #	Description
WP202555	23PC

70PC 1/4" DR. 6 POINT SOCKET SET

- 1/4 Drive: 10PC 6pt SAE socket: 5/32", 3/16", 7/32", 1/4", 9/32", 5/16", 11/32", 3/8", 7/16", 1/2"
- 1/4 Drive: 10PC 6pt Metric socket: 5, 5.5, 6, 7, 8, 9, 10, 11, 12, 13mm
- 1/4 Drive: 6PC 6pt SAE deep socket: 1/4", 9/32", 5/16", 11/32", 3/8", 7/16"
- 1/4 Drive: 6PC 6pt Metric deep socket: 6, 7, 8, 9, 10, 11mm
- 1PC 1/4" universal joint
- 12PC nut driver
- 1PC 1/4"DR. coupler
- 1PC 1/4"x75mm(3") extension bar
- 1PC 1/4"x150mm(6") extension bar
- 1PC 1/4" DR. quick release ratchet handle 45T



- 1PC 1/4"DR. spinner handle
- 20PC bits with holder



Model #	Description
WP202522	70PC

47PC 3/8" DR. 6 POINT SOCKET SET

- 3/8 Drive: 10PC 6pt SAE socket: 1/4", 5/16", 3/8", 7/16", 1/2", 9/16", 5/8", 11/16", 3/4", 13/16"
- 3/8 Drive: 10PC 6pt Metric socket: 9, 10, 11, 12, 13, 14, 15, 16, 17, 18mm
- 1PC 3/8"DR.universal joint
- 12PC nut driver
- 1PC 3/8"x75mm(3")extension bar
- 1PC 3/8"x150mm(6")extension bar
- 1PC 3/8"DR. quick release ratchet handle 45T
- 1PC magnetic bit holder
- 10PC bits with holder



Model #	Description
WP202523	47PC

75PC METRIC SOCKET SET

- 1PC 3/8" DR. quick release ratchet handle 72T
- 5PC 1/4" 6PT deep sockets: 6, 7, 8, 9, 10mm
- 5PC 3/8" 6PT deep sockets: 11, 12, 13, 14, 15mm
- 10PC 1/4" 6PT standard sockets: 5, 5.5, 6, 7, 8, 9, 10, 11, 12, 13mm
- 8PC 3/8" 6PT standard sockets: 8, 10, 11, 12, 13, 14, 15, 16mm
- 1PC Magnet bit holder
- 40PC Bits with holder
- 2PC Extension bar: 3/8"x75mm(3") & 1/4"x75mm(3")
- 1PC Adaptor: 3/8Fx1/4M
- 2PC Universal Joint: 3/8" & 1/4"



Model #	Description
WP202524	75PC

30PC 1/2" DR. 6 POINT SOCKET SET

- 1/2 Drive: 12PC 6pt SAE socket: 5/16", 3/8", 7/16", 1/2", 9/16", 5/8", 11/16", 3/4", 13/16", 7/8", 15/16", 1"
- 1/2 Drive: 14PC 6pt Metric socket: 8, 9, 10, 11, 12, 13, 14, 15, 16, 17, 18, 19, 20, 21mm
- 1PC 1/2" Dr. universal joint
- 1PC 1/2"x75mm(3") extension bar
- 1PC 1/2"x125mm(5") extension bar
- 1PC 1/2"Dr. quick release ratchet handle 45T



Model #	Description
WP202525	30PC

39PC 1/4" + 3/8"DR. SOCKET SET

- 15PC SAE Socket (1/4 inch Drive)
- 6 Point: 5/32", 3/16", 7/32", 1/4", 9/32", 5/16", 11/32", 3/8", 13/32", 7/16", 15/32", 1/2"
- 8 Point: 1/4", 5/16", 3/8"
- 13PC Metric Socket (1/4 inch Drive)
- 6 Point: 4, 4.5, 5, 5.5, 6, 6.5, 7, 8, 9, 10, 11, 12, 13 mm
- 3PC SAE Socket (3/8 inch Drive)
- 6 Point: 7/16", 1/2", 9/16"
- 3PC Metric Socket (3/8 inch Drive)
- 6 Point: 11, 12, 13 mm
- 1PC 1/4 inch Drive spinner handle

- 1PC 3/8 inch Ratchet handles with quick release mechanism
- 1PC 1/4 inch (M) x 3/8 inch (F) adapter
- 1PC 1/4 inch Drive extension bar of 3 inch Long
- 1PC Spin disk
- 1PC Molded case



Model #	Description
WP202536	39PC

24PC SOCKET SET

- 10PC 3/8"DR. SAE sockets: 5/16", 3/8", 7/16", 1/2", 9/16", 5/8", 11/16", 3/4", 13/16", 7/8"
- 11PC 3/8" metric sockets: 9, 10, 11, 12, 13, 14, 15, 16, 17, 18, 19mm
- 1PC 75mm(3") extension bar
- 1PC 5/8"(16mm) spark plug
- 1PC 3/8" ratcheting handle
- 1PC durable blow molded case



Model #	Description
WP202541	24PC

32PC SOCKET SET

- CR-V sockets
- 10PC 3/8"DR. SAE sockets: 5/16", 3/8", 7/16", 1/2", 9/16", 5/8", 11/16", 3/4", 13/16", 7/8"
- 11PC 3/8" metric sockets: 9, 10, 11, 12, 13, 14, 15, 16, 17, 18, 19mm
- 7PC CR-V combination wrenches: 3/8", 7/16", 1/2", 9/16", 5/8", 11/16", 3/4"
- 1PC 3" extension bar
- 2PC spark plug: 13/16"(21mm), 5/8"(16mm)
- 1PC 3/8" DR. ratchet handle
- 1PC durable blow molded case



Model #	Description
WP202528	32PC

37PC 1/4" DR. SOCKET SET

- 1PC 1/4" DR. Quick release ratchet handle, 72T
- 1PC Universal Joints
- 1PC 75mm extension bar
- 1PC plug socket
- 1PC 1/4" spinner handle
- 12PC 1/4" DR. Sockets: 4, 5, 5.5, 6, 7, 8, 9, 10, 11, 12, 13, 14mm
- 20PC Bit set



Model #	Description
WP202547	37PC

24PC 1/2" DR. SOCKET SET

- 17pcs 1/2" Dr, CRV 6PT Socket: 8, 10, 12, 13, 14, 15, 16, 17, 18, 19, 21, 22, 23, 24, 27, 30, 32mm
- 2pcs extension bar: 3" & 5"
- 2pcs spark plug socket: 16mm & 21mm
- 1pc universal joint: Dr. 1/2"
- 1pc F bar: 15"
- 1pc 1/2" ratchet handle
- 1pc tool box 45x19x5.5cm



Model #	Description
WP202564	24pcs

46PC 1/4" DR. SOCKET SET

- 1PC 1/4" Dr. ratchet handle, 72T
- 1PC 1/4" spinner handle
- 1PC 1/4" universal joint
- 1PC bit adapter
- 1PC T-shaped slide handle 110mm
- 1PC flexible extension bar
- 2PC extension bar 2", 4"
- 3PC hex key: 1.5, 2, 2.5mm
- 13PC 1/4" Sockets: 4, 4.5, 5, 5.5, 6, 7, 8, 9, 10, 11, 12, 13, 14 mm
- 21PC x S2 alloy steel bits socket: PH1, PH2, PH3, PZ1, PZ2, PZ3; H3, H4, H5, H6, H7, H8; SL4 SL5.5 SL7; T10 T15 T20 T25 T30 T40



Model #	Description
WP202540	46PC

123PC SOCKET SET

- 3PC CR-V quick-release ratchet handle: 1/4", 3/8", 1/2"
- 10PC 1/4" drive CR-V sockets: 4, 5, 6, 7, 8, 9, 10, 11, 12, 13mm
- 4PC 1/4" drive CR-V deep sockets: 8, 9, 10, 12mm
- 11PC 3/8" drive CR-V sockets: 9, 10, 12, 13, 14, 15, 16, 17, 18, 19mm
- 4PC 3/8" drive CR-V deep sockets: 13, 14, 15, 17mm
- 8PC 3/8" drive CR-V sockets: 8, 10, 11, 12, 14, 16, 18, 20mm
- 7PC 1/2" drive CR-V sockets: 20, 21, 22, 24, 27, 30, 32mm
- 3PC CR-V universal joints: 1/4", 3/8", 1/2" drive
- 2PC CR-V adaptors: 1/2" drive M X 3/8" Drive F, 1/4" Drive M X 3/8" Drive F
- 1PC 1/4" drive CR-V coupler
- 1PC 1/4" drive CR-V spinner handle
- 17PC 3/8" drive CR-V bits sockets: T20, T30, T40, T45, T50, T55, T60, FD5.5, FD6.5, PH1, PH2, PZ1, PZ2, H3, H4, H5, H6
- 18PC 25mm S2 screwdriver bits with holder
- 3PC 3/8" drive CR-V spark plug sockets: 14mm, 16mm, 21mm
- 11PC CR-V Combination spanners: 8, 9, 10, 11, 12, 13, 14, 16, 17, 18, 19mm
- 5PC CR-V extension bars: 1/4" DR.x50mm, 3/8"DR.x75mm, 3/8"DR.x150mm, 1/2" DR.x125mm, 1/2"DR.x250mm
- 1PC 1/2" drivex250mm CR-V flex handle
- 2PC chrome molybdenum screwdrivers: 6X100mm, PH2X100mm
- 1PC 1/2" drive oil filter wrench
- 1PC voltage tester
- 1PC CR-V 12.5mm socket for cover of cylinder: T52X100L
- 9PC CR-V long hex key set: 1.5, 2, 2.5, 3, 4, 5, 6, 8, 10mm
- 1PC blow mould case



Model #	Description
WP202532	123PC



164PC MECHANICS TOOL KIT

- 11 PC 1/4 in. DR. SAE (6-Point) Sockets: 5/32, 3/16, 7/32, 1/4, 9/32, 5/16, 11/32, 3/8, 7/16, 1/2, 9/16 in.
- 12 PC 1/4 in. DR. Metric (6-Point) Sockets: 4, 5, 5.5, 6, 7, 8, 9, 10, 11, 12, 13, 14mm
- 5 PC 1/4 in. DR. SAE (6-Point) Deep Sockets: 3/16, 7/32, 1/4, 9/32, 5/16 in.
- 5 PC 1/4 in. DR. Metric (6-Point) Deep Sockets: 7, 8, 9, 10, 11 mm
- 1 PC 1/4 in. DR. 75mm(3"). Extension Bar
- 1 PC 1/4 in. DR. Quick Release Ratchet Handle
- 1PC 1/4 Universal Joint
- 10 PC 3/8 in. DR. SAE (6-Point) Sockets: 1/4, 5/16, 3/8, 7/16, 1/2, 9/16, 5/8, 11/16, 3/4, 13/16 in.
- 13PC 3/8 in. DR. Metric (6-Point) Sockets: 6, 7, 8, 9, 10, 11, 12, 13, 14, 15, 16, 17, 18mm
- 6PC 3/8 in. DR. SAE (12-Point) Sockets: 5/16, 3/8, 7/16, 1/2, 9/16, 5/8 in.
- 6PC 3/8 in. DR. Metric (12-Point) Sockets: 10, 12, 13, 14, 15, 17mm
- 6PC 3/8 in. DR. SAE (6-Point) Deep Sockets: 7/16, 1/2, 9/16, 5/8, 11/16, 3/4 in.
- 6PC 3/8 in. DR. Metric (6-Point) Deep Sockets: 10, 12, 13, 14, 15, 18mm
- 1PC 3/8 in. DR. Spark Plug Socket: 13/16 in.
- 1PC 3/8 in. DR. 75mm(3") Extension Bar
- 1PC 3/8 in. DR. Quick Release Ratchet Handle
- 1PC 3/8 Universal Joint
- 7PC 1/2 in. DR. SAE (6-Point) Sockets: 7/16, 1/2, 9/16, 5/8, 11/16, 3/4, 1 in.
- 6PC 1/2 in. DR. Metric (6-Point) Sockets: 14, 15, 16, 17, 18, 19mm
- 1PC 1/2 in. DR. 75mm(3") Extension Bar
- 1PC 1/2 in. DR. Quick Release Ratchet Handle
- 1 PC 1/2 Universal Joint
- 6PC SAE Combo Wrenches: 5/16, 3/8, 7/16, 1/2, 9/16, 5/8 in.
- 6PC Metric Combo Wrenches: 10, 12, 13, 14, 15, 17 mm
- 1PC Magnetic Bit Driver
- 19PC 25mm screwdriver bits
- 1PC Adaptor
- 7PC SAE Hex Key Wrenches: 1/16, 5/64, 3/32, 1/8, 5/32, 3/16, 1/4 in.
- 7PC Metric Hex Key Wrenches: 1.5, 2, 2.5, 3, 4, 5, 6 mm
- 7PC SAE Nut Driver Bits: 3/16, 1/4, 9/32, 5/16, 11/32, 3/8, 7/16 in.
- 7PC Metric Nut Driver Bits: 5, 6, 7, 8, 9, 10, 11 mm



164 PIECE **MM SAE** **CR-V** STEEL



Model #	Description
WP202530	164PC

145PC MECHANICS TOOL KIT

- 11PC 1/4 in. Drive SAE sockets: 5/32, 3/16, 7/32, 1/4, 9/32, 5/16, 11/32, 3/8, 7/16, 1/2, 9/16 in
- 12PC 1/4 in. Drive Metric sockets: 4, 5, 5.5, 6, 7, 8, 9, 10, 11, 12, 13, 14 mm
- 1PC 1/4 in. Drive 3 in. Extension bar
- 1PC 1/4 in. Drive quick release ratchet handle
- 1PC 1/4 in. Driver universal joint
- 6PC 3/8 in. Drive SAE sockets: 1/2, 9/16, 5/8, 11/16, 3/4, 13/16 in.
- 8PC 3/8 in. Drive Metric sockets: 12, 13, 14, 15, 16, 17, 19, 21 mm
- 1PC 3/8 in. Drive spark plug socket: 13/16 in.
- 1PC 3/8 in. Drive 3 in. extension bar
- 1PC 3/8 in. Drive quick release ratchet handle
- 1PC 3/8 in. Driver universal joint
- 5PC SAE combination wrenches: 3/8, 7/16, 1/2, 9/16, 5/8 in.
- 5PC Metric combination wrenches: 10, 11, 13, 14, 16mm 1PC Magnetic bit holder
- 59PC 1" S2 screwdriver bits
- 1PC Adaptor
- 8PC SAE hex key wrenches: 1/16, 5/64, 3/32, 1/8, 5/32, 3/16, 7/32, 1/4in
- 8PC Metric hex key wrenches: 1.5, 2, 2.5, 3, 4, 5, 5.5,

- 6mm
- 7PC SAE nut driver bits: 3/16, 1/4, 9/32, 5/16, 11/32, 3/8, 7/16 in.
- 7PC Metric nut driver bits: 5, 6, 7, 8, 9, 10, 11mm

145 PIECE **CR-V** STEEL **MM SAE**



Model #	Description
WP202531	145PC

108PC MECHANICS TOOL SET

- 17PC 1/2 in. Drive Metric (6-Point) Short Sockets (CR-V): 10, 11, 12, 13, 14, 15, 16, 17, 18, 19, 20, 21, 22, 24, 27, 30, 32mm
- 5PC 1/2 in. Drive Metric (6-Point) Long Sockets (CR-V): 14, 15, 17, 19, 22mm
- 2PC 1/2 in. Drive Extension Bar: 5", 10"
- 1PC 1/2 in. Driver Universal joint
- 8PC 1/2 in. Drive E Sockets (CR-V): E10, E11, E12, E14, E16, E18, E20, E24
- 1PC 1/2 in. Drive Quick Release Ratchet Handle
- 2PC 1/2 in. Drive Spark Plug Sockets (CR-V): 16mm, 21mm
- 1PC 1/2 in. Driver Adaptor
- 13PC 1/4 in. Drive Metric (6-Point) Short Sockets (CR-V): 4, 4.5, 5, 5.5, 6, 7, 8, 9, 10, 11, 12, 13, 14mm
- 8PC 1/4 in. Drive Metric (6-Point) Long Sockets (CR-V): 6, 7, 8, 9, 10, 11, 12, 13mm
- 2PC 1/4 in. Drive Extension Bar: 2", 3"
- 1PC 1/4 in. Driver Universal joint
- 1PC 1/4 in. Drive Quick Release Ratchet Handle
- 5PC 1/4 in. Drive E Sockets (CR-V): E4, E5, E6, E7, E8
- 1PC 1/4 in. Driver Slider
- 3PC Hex Key (Carbon Steel) : 1.5, 2, 2.5mm
- 1PC 1/4" X 6" Piercing Bar
- 18PC 1/4 in. Drive Bits: SL4, SL5.5, SL6.5, PH1, PH2,

- PZ1, PZ2, H3, H4, H5, H6, T8, T10, T15, T20, T25, T27, T30
- 17PC 5/16 in. Drive Bits: SL8, SL10, SL12; T40, T45, T50, T55, T60; PH3, PH4; PZ3, PZ4; HEX7, HEX8, HEX10, HEX12, HEX14
- 1PC 1/2" Flexible Sleeve
- Blow mould case

MM **CR-V** STEEL



Model #	Description
WP202535	172PC

123PC MECHANICS TOOL SET

- 7PC 1/2" drive CR-V sockets: 20, 21, 22, 24, 27, 30, 32mm
- 11PC 3/8" drive CR-V sockets: 9, 10, 12, 13, 14, 15, 16, 17, 18, 19mm
- 4PC 3/8" drive CR-V deep sockets: 13, 14, 15, 17mm
- 10PC 1/4" drive CR-V sockets: 4, 5, 6, 7, 8, 9, 10, 11, 12, 13mm
- 4PC 1/4" drive CR-V deep sockets: 8, 9, 10, 12mm
- 4PC 1/2" drive CR-V impact sockets: 17, 19, 21, 23mm
- 2PC 3/8" drive CR-V spark plug sockets: 16mm, 21mm
- 5PC CR-V extension bars: 1/4" DR.x50mm, 3/8"DR.x75mm, 3/8"DR.x150mm, 1/2" DR.x125mm, 1/2"DR.x250mm
- 3PC CR-V universal joints: 1/4", 3/8", 1/2" drive
- 1PC CR-V 3 way adapter 1/2"
- 2PC CR-V adaptors: 1/2" drive m x 3/8" drive f, 1/4" drive m x 3/8" drive f
- 1PC 1/4" drive CR-V coupler
- 1PC 1/4" drive CR-V spinner handle
- 1PC 1/4" ratcheting handle
- 1PC 3/8" ratcheting handle
- 1PC 1/2" ratcheting handle
- 17PC 3/8" drive CR-V/s2 bits sockets: T20, T30, T40, T45, T50, T55, T60, FD5.5, FD6.5, PH1, PH2, PH1, PZ2, H3, H4, H5, H6
- 1PC 175mm(7") linesman plier
- 1PC 160mm(6") long nose plier
- 1PC pin wrench socket
- 1PC oil filter wrench
- 1PC voltage tester
- 1PC CR-V 12.5mm socket for cover of cylinder: T52x100L
- 4PC chrome molybdenum screwdrivers: 6x100mm, 6x38mm, PH2x100mm, PH2x38mm
- 18PC 25mm S2 screwdriver bits with holder
- 11PC CR-V combination spanners: 8, 9, 10, 11, 12, 13, 14, 16, 17, 18 19mm
- 9PC CR-V long hex key set: 1.5, 2, 2.5, 3, 4, 5, 6, 8, 10mm
- 1PC blow mould case



Model #	Description
WP202533	123PC

172PC 1/4"+3/8"+1/2" DRIVE MECHANICS TOOL SET

- 1PC 1/4" reversible quick-release ratchet with 72 teeth
- 1PC 3/8" reversible quick-release ratchet with 72 teeth
- 1PC 1/2" reversible quick-release ratchet with 72 teeth
- 13PC 1/4" DR. socket,6PT,CR-V: 4, 4.5, 5, 5.5, 6, 7, 8, 9, 10, 11, 12, 13, 14mm
- 7PC 1/4" DR. deep socket,6PT,CR-V: 4, 5, 6, 7, 8, 9, 10mm
- 10PC 3/8" DR. socket,6PT,CR-V: 10, 11, 12, 13, 14, 15, 16, 17, 18, 19mm
- 6PC 3/8" DR. deep socket,6PT,CR-V: 10, 11, 12, 13, 14, 15mm
- 17PC 1/2" DR. socket,6PT,CR-V: 10, 11, 12, 13, 14, 15, 16, 17, 18, 19, 20, 21, 22, 24, 27, 30, 32mm
- 5PC 1/2" DR. deep socket, 6PT, CR-V: 16, 17, 18, 19, 22mm
- 5PC 1/4" DR. E-style socket,CR-V: E4, E5, E6, E7, E8
- 6PC 3/8" DR. E-style socket,CR-V: E10, E11, E12, E14, E16, E18
- 2PC 1/2" DR. E-style socket,CR-V: E20, E24
- 3PC spark plug socket,CR-V: 1/2x16mm, 1/2x21mm, 3/8x21mm
- 30PC 1/4" bits socket, CR-V+S2: H3, H4, H5, H6, T8, T9, T10, T15, T20, T25, T27, T30, T8, T9, T10, T15, T20, T25, T27, T30, FD4, FD5.5, FD6.5, FD7, pH0, pH1, pH2, PZ0, PZ1, PZ2
- 20PC 1/4" screwdriver bits with holder, S2: T8, T9, T10, T15, T20, T25, T30, FD4, FD5.5, FD7, Tx8, Tx9, Tx10, Tx15, Tx20, Tx25, Tx30, H3, H4, H5
- 24PC 5/16" screwdriver bits, S2: H7, H8, H10, H12, H14, FD8, FD10, FD12, PH3, PH4, PZ3, PZ4, T40, T45, T50, T55, T60, T70, T40, T45, T50, T55, T60, T70
- 7PC METRIC allen key set: 1.27, 1.5, 2, 2.5, 3, 4, 5
- 5PC extension bar, CR-V: 1/2x5", 1/2x10", 3/8x6", 1/4x2", 1/4x4"
- 3PC universal joint, CR-V: 1/4", 1/2", 3/8"
- 3PC coupler, CR-V: 1/2x8mm, 3/8x8mm, 1/4x1/4"
- 1PC spinner handle
- 1PC 1/4" 110mm sliding bar, CR-V
- 1PC 3-way adaptor: 1/2mx3/8f, CR-V
- Molded case



Model #	Description
WP202545	172PC



320PC MECHANICS TOOL SET WITH HEAVY DUTY CASE BOX

- 1PC 30x108mm magnetic bit driver handle
- 40PC hex key: (short arm) 1.5, 2, 2.5, 3, 4, 4.5, 5, 5.5, 6, 7, 8mm; 0.05", 1/16", 5/64", 3/32", 7/64", 1/8", 9/64", 5/32", 3/16", 7/32", 1/4"; (long arm) 1.5, 2, 2.5, 3, 4, 4.5, 5, 5.5, 6mm; 5/64", 3/32", 7/64", 1/8", 9/64", 5/32", 3/16", 7/32", 1/4"
- 23PC 1/4" Dr. sockets in metric & SAE: 4, 5, 5.5, 6, 7, 8, 9, 10, 11, 12, 13, 14mm; 5/32", 3/16", 7/32", 1/4", 1/4", 9/32", 5/16", 11/32", 3/8", 7/16", 1/2", 9/16", 6pt
- 10PC 1/4" Dr. SAE sockets: 3/16", 7/32", 1/4", 9/32", 5/16", 11/32", 3/8", 7/16", 1/2", 9/16", 12pt
- 21PC 1/4" deep sockets in metric & SAE: 4, 5, 6, 7, 8, 9, 10, 11, 12, 13, 14mm, 3/16", 7/32", 1/4", 9/32", 5/16", 11/32", 3/8", 7/16", 1/2", 9/16", 6pt
- 12PC nut driver: 5, 6, 7, 8, 9, 10mm, 3/16", 1/4", 9/32", 5/16", 11/32", 3/8"
- 26PC 3/8" Dr. sockets in metric and SAE: 6, 7, 8, 9, 10, 11, 12, 13, 14, 15, 16, 17, 18, 19, 20mm; 1/4", 5/16", 3/8", 7/16", 1/2", 9/16", 5/8", 11/16", 3/4", 13/16", 7/8", 6pt
- 23PC 3/8" Dr. sockets in metric and SAE: 8, 9, 10, 11, 12, 13, 14, 15, 16, 17, 18, 19mm; 1/4", 5/16", 3/8", 7/16", 1/2", 9/16", 5/8", 11/16", 3/4", 13/16", 7/8", 12pt
- 5PC 3/8" Dr. SAE sockets: 1/4", 5/16", 3/8", 7/16", 1/2", 8pt
- 6PC 3/8" deep sockets in metric and SAE: 12, 13, 14mm; 3/8", 7/16", 1/2", 6pt
- 13PC 1/2" Dr. sockets in metric and SAE: 9, 10, 12, 13, 14, 15, 16mm; 1/2", 9/16", 5/8", 11/16", 3/4", 13/16", 12pt
- 4PC extension bar: 1/4"x1-1/2", 1/4"x3", 3/8"x3", 1/2"x3"
- 3PC adaptor: 1/4"MX3/8"F, 3/8"MX1/4"F, 1/2"MX3/8"F
- 1PC 25mm x1/4" adaptor
- 3PC 3/8" & 1/2" & 1/4" quick-release ratchet handle
- 13PC 1/4" Dr. Bit sockets
- 12PC 3/8" Dr. Bit Sockets
- 8PC Combination Wrench
- 96PC 1" S2 bits
- 1PC blow molded case



Model #	Description
WP202538	320PC

450PC MECHANICS TOOL SET WITH HEAVY DUTY CASE BOX

- 1PC 25mm x1/4" adaptor
- 1PC 30x108mm magnetic bit driver handle
- 175PC 1" S2 bits
- 40PC hex key: (short arm) 1.5, 2, 2.5, 3, 4, 4.5, 5, 5.5, 6, 7, 8mm; 0.05", 1/16", 5/64", 3/32", 7/64", 1/8", 9/64", 5/32", 3/16", 7/32", 1/4"; (long arm) 1.5, 2, 2.5, 3, 4, 4.5, 5, 5.5, 6mm; 5/64", 3/32", 7/64", 1/8", 9/64", 5/32", 3/16", 7/32", 1/4"
- 3PC 3/8" & 1/2" & 1/4" quick-release ratchet handle
- 12PC Combination Wrench
- 4PC mini Combination Wrench
- 23PC 1/4" Dr. sockets in metric & SAE: 4, 5, 5.5, 6, 7, 8, 9, 10, 11, 12, 13, 14mm; 5/32", 3/16", 7/32", 1/4", 1/4", 9/32", 5/16", 11/32", 3/8", 7/16", 1/2", 9/16", 6pt
- 10PC 1/4" Dr. SAE sockets: 3/16", 7/32", 1/4", 9/32", 5/16", 11/32", 3/8", 7/16", 1/2", 9/16", 12pt
- 21PC 1/4" deep sockets in metric & SAE: 4, 5, 6, 7, 8, 9, 10, 11, 12, 13, 14mm, 3/16", 7/32", 1/4", 9/32", 5/16", 11/32", 3/8", 7/16", 1/2", 9/16", 6pt
- 12PC nut drivers
- 30PC 3/8" Dr. sockets in metric and SAE: 6, 7, 8, 9, 10, 11, 12, 13, 14, 15, 16, 17, 18, 19, 20, 21, 22mm; 1/4", 5/16", 3/8", 7/16", 1/2", 9/16", 5/8", 11/16", 3/4", 13/16", 7/8", 15/16", 1", 6pt
- 28PC 3/8" Dr. sockets in metric and SAE: 6, 7, 8, 9, 10, 11, 12, 13, 14, 15, 16, 17, 18, 19, 21mm; 1/4", 5/16", 3/8", 7/16", 1/2", 9/16", 5/8", 11/16", 3/4", 13/16", 7/8", 15/16", 1", 12pt
- 5PC 3/8" SAE Dr. sockets: 1/4", 5/16", 3/8", 7/16", 1/2", 8pt
- 19PC 3/8" deep sockets in metric and SAE: 12, 13, 14, 15, 16, 17, 18, 19mm; 3/8", 7/16", 1/2", 9/16", 5/8", 11/16", 3/4", 13/16", 7/8", 15/16", 1"
- 4PC 3/8" E-sockets: E10, E12, E14, E16
- 16PC 1/2" Dr. sockets in metric and SAE: 9, 10, 11, 12, 13, 14, 15, 16, 17mm; 1/2", 9/16", 5/8", 11/16", 3/4", 13/16", 7/8", 12pt
- 4PC Dr. spark plug sockets in metric and SAE: 3/8"x5/8", 3/8"x3/4", 3/8"x18mm, 1/2"x5/8"
- 6PC extension bar: 1/4"x1-1/2", 1/4"x3", 3/8"x1-1/2", 3/8"x3", 3/8"x6", 1/2"x3"
- 1PC bit holder: 1/4"x1/4"
- 4PC adaptor: 1/4"MX3/8"F, 3/8"MX1/4"F, 3/8"MX1/2"F, 1/2"MX3/8"F
- 16PC 1/4" Dr. Bit sockets
- 15PC 3/8" Dr. Bit sockets
- 1PC blow molded case



Model #	Description
WP202539	450PC



230PC MECHANICS TOOL KIT IN HARD CASE

- 50PC screwdriver bits
- 1PC magnetic bit driver handle
- 40PC hex key : (short arm) 1.5, 2, 2.5, 3, 4, 4.5, 5, 5.5, 6, 7, 8mm, 0.05", 1/16", 5/64", 3/32", 7/64", 1/8", 9/64", 5/32", 3/16", 7/32", 1/4"; (long arm) 1.5, 2, 2.5, 3, 4, 4.5, 5, 5.5, 6mm, 5/64", 3/32", 7/64", 1/8", 9/64", 5/32", 3/16", 7/32", 1/4"
- 3PC 1/4" & 3/8" & 1/2" quick-release ratchet handle
- 6PC combination wrench
- 23PC 1/4" Dr. sockets in Metric & SAE: 4, 5, 5.5, 6, 7, 8, 9, 10, 11, 12, 13, 14mm, 5/32", 3/16", 7/32", 1/4", 9/32", 5/16", 11/32", 3/8", 7/16", 1/2", 9/16", 6pt
- 10PC 1/4" Dr. 12PT, SAE sockets: 3/16", 7/32", 1/4", 9/32", 5/16", 11/32", 3/8", 7/16", 1/2", 9/16"
- 21PC 1/4" deep sockets in metric & SAE: 4, 5, 6, 7, 8, 9, 10, 11, 12, 13, 14mm, 3/16", 7/32", 1/4", 9/32", 5/16", 11/32", 3/8", 7/16", 1/2", 9/16", 6pt
- 27PC 3/8" Dr. sockets in metric & SAE: 6, 7, 8, 9, 10, 11, 12, 13, 14, 15, 16, 17, 18, 19, 20, 21mm, 1/4", 5/16", 3/8", 7/16", 1/2", 9/16", 5/8", 11/16", 3/4", 13/16", 7/8", 6pt
- 25PC 3/8" Dr. 12PT, sockets in Metric & SAE: 6, 7, 8, 9, 10, 11, 12, 13, 14, 15, 16, 17, 18, 19, 21mm, 1/4", 5/16", 3/8", 7/16", 1/2", 9/16", 5/8", 11/16", 3/4", 13/16"
- 10PC 1/2" Dr. 12PT, sockets in metric & SAE: 17, 18, 19, 20, 21mm, 11/16", 3/4", 13/16", 7/8", 15/16"
- 12PC nut drivers
- 2PC extension bar: 1/4" x 1-1/2", 3/8" x 3"
- 1PC blow molded case



Model #	Description
WP202537	230PC

136PC TOOL SET WITH ROLLER SEAT

- 1PC 6" long nose pliers
- 5PC combination spanners: 8, 10, 11, 13, 15mm
- 9PC SAE hex key
- 1PC magnetic bit holder handle
- 60PC CR-V 25mm bits
- 1PC 3/8" DR. ratchet handle
- 8PC 3/8" DR. metric sockets: 8, 9, 10, 11, 12, 14, 15, 16mm
- 8PC 3/8" DR. SAE sockets: 5/16", 3/8", 7/16", 1/2", 9/16", 5/8", 11/16", 3/4"
- 1PC 3/8" DR. 75mm extension bar
- 1PC 3/8" DR. spark plug socket: 16mm
- 40PC cable ties
- 1PC 2-drawer roller seat



Model #	Description
WP209036	136PC



239PC MECHANICS TOOL KIT

- 1pc 3/8" Dr. ratchet handle
- 13pc 3/8" Dr. sockets: 6, 8, 9, 10, 11, 12, 13, 14, 16, 17, 19, 21, 22mm
- 11pc 1/4" Dr. sockets: 4, 5, 5.5, 6, 7, 8, 9, 10, 11, 12, 13mm
- 4pc 1/4" deep sockets: 5, 6, 7, 8mm
- 4pc 3/8" deep sockets: 8, 10, 11, 12mm;
- 1pc 3/8" Dr. FX 1/4", Dr. M adapter
- 1pc 1/4" Dr. X 50mm extension bar
- 1pc 3/8" Dr. X 70mm extension Bar
- 1pc 1/4" Dr. sliding bar
- 11pc metric CRV hex key set: 1.27, 1.5, 2, 2.5, 3, 3.5, 4, 4.5, 5, 5.5, 6mm
- 11pc SAE CRV hex key set: 0.05, 1/16, 5/64, 3/32, 7/64, 1/8, 9/64, 5/32, 3/16, 7/32, 1/4"
- 1pc magnetic bits holder handle
- 60pc 25mm(1") CRV bits
- 6pc nut drivers: 5, 6, 7, 8, 9, 10mm
- 8pc combination spanners: 6, 8, 10, 11, 12, 14, 16, 17mm
- 1pc 200mm adjustable wrench
- 1pc 180mm combination pliers
- 1pc 160mm long nose pliers
- 1pc 250mm groove joint pliers
- 6pc screwdriver: slotted: 5.5x75, 6.5x100, Phillips: PH0X75, PH2X100, Square: S1X100, S2X100mm
- 1pc crimping tools
- 55pc terminals
- 1pc 18MM snap off knife
- 20pc cable tie
- 1pc mini hacksaw
- 6pc precision screwdriver: 1.4, 2.0, 2.4, 3.0, PH0, PH1
- 10pc 18MM snap off knife blades with plastic box
- 1pc metal box



Model #	Description
WP209033	239PC

93PC TOOL SET WITH 5-TRAY CANTILEVER TOOL BOX

- 11Pcs Combination spanner: 8, 9, 10, 11, 12, 13, 14, 16, 17, 18, 19mm
- 1Pc 8" Combination pliers
- 1Pc 6" Long nose pliers
- 1Pc 7" Diagonal cutting pliers
- 40Pcs CR-V Screwdriver bits with holder;
- 1Pc Magnetic Bit Driver 10x75mm
- 1Pc Flexible extension bar
- 9Pcs Hex key 1.5, 2, 2.5, 3, 4, 5, 6, 8, 10mm
- 1Pc 10" Adjustable wrench
- 1Pc 10" Curved jaw lock wrench
- 1Pc 8" Half round file
- 1Pc 1/2" Dr. Universal joint
- 1Pc Spark plug socket 1/2" Dr. 21mm
- 2Pcs 1/2" Dr. Extension bar: 125mm(5"), 250mm(10")
- 1Pc 3-Way adaptor 3/8F-1/2M
- 1Pc 1/2" Dr. Flex handle, 380mm
- 1Pc 1/2" Dr. ratchet wrench, 72T
- 17Pcs 1/2" Hexagonal Socket: 10, 11, 12, 13, 14, 15, 16, 17, 18, 19, 20, 21, 22, 24, 27, 30, 32mm
- 1Pc 5-tray cantilever tool box

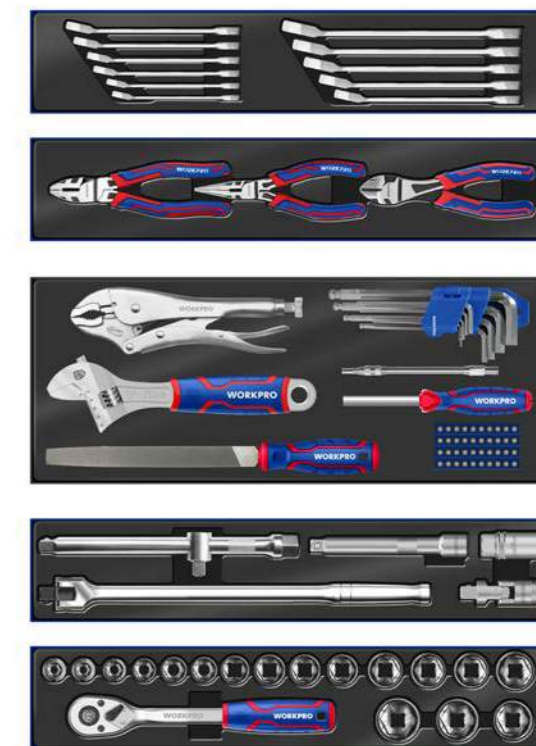

Model #	Description
WP209035	93PC



PINK LADY TOOL SET FOR HOME REPAIRING

- 5pcs precision screwdrivers
- 8pcs SAE hex keys
- 1pc magnetic bit holder
- 40pcs 1" screwdriver bits
- 1pc AAA 9LED aluminum flashlight with lanyard
- 32pc hardware
- 1pc 6" long nose pliers
- 1pc 6" slip joint pliers
- 1pc 6" adjustable wrench
- 1pc safety knife
- 10pcs SK5 knife blades
- 1pc 8-1/2" scissors
- 1pc 9" level
- 1pc 12oz claw hammer
- 1pc 10ft auto-lock tape measure with SAE and metric marking blade
- 1pc tool bag



Model #	Description
WP206801	106pcs

103PC LADY TOOL SET (SAE)

- 1PC 152mm(6") Slip joint pliers
- 1PC 152mm(6") Long nose pliers
- 1PC 152mm(6") adjustable wrench
- 5PC precision screwdriver set (SAE): SL5/64", 3/32", 1/8", PH0, PH00
- 1PC magnetic screwdriver bit holder
- 40PC 1" bits with holder (SAE):PH0, PH1X2, PH2X5, PH3X2, 1/8, 5/32, 3/16, 7/32, 1/4, 9/32, PZ0, PZ1, PZ2, PZ3, SOX2, S1X2, S2X4, S3X2, H1/16, H3/32, H1/8, H5/32, H3/16, H1/4, T10, T15, T20, T25
- 1PC 9" magnetic torpedo level
- 1PC 16 oz. fiberglass claw hammer
- 1PC 16FT.(5m) tape measure
- 1PC utility knife
- 10PC utility knife blades
- 40PC cable ties
- Round pouch

SAE



Model #	Description
WP206800	103PC

103PC LADY TOOL SET (METRIC)

- 1PC 152mm(6") Slip joint pliers
- 1PC 152mm(6") Long nose pliers
- 1PC 152mm(6") adjustable wrench
- 5PC precision screwdriver set (METRIC): SL2, SL2.5, SL3, #0, #00
- 1PC magnetic screwdriver bit holder
- 40PC 1" bits with holder (METRIC): PH0, PH1X2, PH2X5, PH3X2; 3, 4, 5, 5.5, 6, 7, PZ0, PZ1, PZ2, PZ3; SOX2, S1X2, S2X4, S3X2; H1.5, H2.5, H3, H4, H5, H6, T10, T15, T20, T25
- 1PC 225mm(9") magnetic torpedo level
- 1PC 16 oz. fiberglass claw hammer
- 1PC 16FT.(5m) tape measure (MID)
- 1PC utility knife
- 10PC utility knife blades
- 40PC cable ties
- Round pouch

MM



Model #	Description
WP206818	103PC



101PC 12V PINK DRILL AND HOME TOOL SET

- 1pc 12V cordless lithium-ion drill driver
- Lithium-ion battery: 12V 1.5Ah.TORQUE: 20NM.Speed:0-400/0-1500RPM.
- Charging time: 3-5Hrs
- 10 pcs HSS4241 drill bits
- 32 pcs screwdriver bits set
- 1pc 12oz fiberglass handle hammer
- 1pc 225mm(9") torpedo level
- 2pcs 160mm(6") Adjustable wrench
- 1pc 6" long nose pliers
- 1pc screwdriver holder

- 1pc 3m/10ft tape measure
- 1pc 18 mm snap off knife
- 10pcs knife blades
- 32pcs hardware kit
- 8pcs hex key set
- 1pc 13" storage bag



Model #	Description
WP209067	101pcs

PINK CORDLESS DRILL DRIVER SET

- 1pc 12V Cordless Lithium-Ion Drill Driver
- Lithium-ion battery: 12V 1.5Ah.TORQUE: 20NM.Speed:0-400/0-1500RPM.
- Charging time: 3-5Hrs
- 1pc 0.4A Charger
- 10pcs 1" Cr-v drill bits: PH1, PH2, PH3, 1/8, 5/32, 3/16, 1/4, T10, T15, T20
- 6pcs Twist Drill Bits
- 1pc bit holder
- 1pc carrying bag
- 1pc 1500 mAh Lithium-ion battery



Model #	Description
WP206802	21pcs

29PC 3.7V PIVOTING SCREWDRIVER AND TOOL SET

- 1pc 3.7v Li-ion Rechargeable Screwdriver with Adjustable two-position handle
- Lithium-ion battery: 3.7V 1500mAh.TORQUE: 4NM.Speed:235RPM.
- Charging time: 2-3Hrs
- 9pcs CR-V bits: PH 0-1-2,PZ 1-2,T 15- 20,SL 5,H 4+ 1pcs 50mm extension bar
- 1pc 8oz Fiberglass Claw Hammer
- 1pc 225mm(9") Torpedo level
- 1pc 160mm(6") Adjustable wrench
- 1pc 3M/10FT tape measure
- 1pc 18 mm snap off knife
- 10pcs Knife blades
- 1pc 8-1/2" scissors
- 8pcs 6" long nose pliers



Model #	Description
WP209068	29pcs

7PC GARDEN TOOLS SET

- 1pc weeder
- 1pc hand fork
- 1pc hand rake
- 1pc transplanter
- 1pc trowl
- 1pc pruner
- 1 pair of glove
- 1 tool bag



Model #	Description
WP206803	7pcs

5PC GARDEN TOOLS SET

- 1pc trowel
- 1pc transplanter
- 1pc weeder
- 1pc hand rake
- 1pc hand fork
- 1 tool bag



Model #	Description
WP206804	5pcs

3PC+1PC GARDEN TOOL SET

- 1pc trowel
- 1pc pruner
- 1pc cultivator
- 1pair of gloves



BONUS



Model #	Description
WP204505	3pcs+1pcs



SUPER FAST HELICOPTER

- Kit includes wood and small hardware pieces to complete the project
- Requires additional tools to assemble: hammer, safety glasses, tape measure (optional)



Model #	Description
WP206806	20.5x10x8.5cm

MEMORABLE PICTURE FRAME

- Kit includes wood and small hardware pieces to complete the project
- Requires additional tools to assemble: hammer, safety glasses, tape measure (optional)



Model #	Description
WP206812	12.7x2.3x17.5cm

CHRISTMAS TREE

- Kit includes wood and small hardware pieces to complete the project
- Requires additional tools to assemble: hammer, safety glasses, tape measure (optional)



Model #	Description
WP206822	23x8.5x19cm

CLASSIC XYLOPHONE

- Kit includes wood and small hardware pieces to complete the project
- Requires additional tools to assemble: hammer, safety glasses, tape measure (optional)



Model #	Description
WP206807	15x11.5x7cm (Stick: 15.2x2x2cm)

FUNNY TIC TAC TOE

- Kit includes wood and small hardware pieces to complete the project
- Requires additional tools to assemble: hammer, safety glasses, tape measure (optional)



Model #	Description
WP206805	13.5x13.5x3.5cm

WARM BIRD FEEDER

- Kit includes wood and small hardware pieces to complete the project
- Requires additional tools to assemble: hammer, safety glasses, tape measure (optional)



Model #	Description
WP206810	15x12.3x14cm



PULL BACK SPORTS CAR

- Kit includes wood and small hardware pieces to complete the project
- Requires additional tools to assemble: hammer, safety glasses, tape measure (optional)



Model #	Description
WP206808	16x7x5.5cm

POWERFUL TRAIN

- Kit includes wood and small hardware pieces to complete the project
- Requires additional tools to assemble: hammer, safety glasses, tape measure (optional)



Model #	Description
WP206811	12x7x8cm

MYSTERIOUS PIRATE SHIP

- Kit includes wood and small hardware pieces to complete the project
- Requires additional tools to assemble: hammer, safety glasses, tape measure (optional)



Model #	Description
WP206813	17.5x8.5x14.5cm

DIY CONSTRUCTION KIT

- Includes contractor belt
- 7pcs tool kit
- Front loader & excavator build kit



Model #	Description
WP206819	Crane: 23x8.5x19cm; Tractor: 20x9x9.5cm

DIY FIRST RESPONDER KIT

- Includes first responder vest
- 7pcs tool kit
- Helicopter & first truck kit



Model #	Description
WP206820	Ambulance: 15.5x7.5x9cm; Airplane: 20x15x10.5cm

DIY PROJECT KIT

- Includes project belt
- 7pcs tool kit
- Bird feeder & rotary dispenser kit



Model #	Description
WP206821	Candy Machine: 9x13x17cm; Bird House: 13x15x14.5cm

HARDWARE & OTHERS

New design will be released in 2023.





POINT REDEMPTION

REMARK: 1 USD (ORDER VALUE) = 1 POINT

PLASTIC BAG



Model #	Description
WP439016	10 POINTS/PC

BALL PEN



Model #	Description
WP439015	15 POINTS

MULTIFUNCTIONAL BALL PEN



Model #	Description
WP439002	180 POINTS/PC

6-IN-1 SPINNER TOOL



Model #	Description
WP221065	230 POINTS

12" CANVAS ZIPPER BAG



Model #	Description
WP289021	Red, 250 POINTS
WP289022	Blue, 250 POINTS

CAP



Model #	Description
WP439004	350 POINTS

12OZ CAR CUP



Model #	Description
WP439001	500 POINTS

3-IN-1 MULTIPURPOSE KEY CHAIN



Model #	Description
WP389004	250 POINTS

CANVAS BAG



Model #	Description
WP281031	380 POINTS

20OZ TUMBLER



Model #	Description
WP389013	680 POINTS



NOTEBOOK



Model #	Description
WP439003	750 POINTS

GOLF UMBRELLA



Model #	Description
WP439009	1000 POINTS

T-SHIRT



Model #	Description
WP439005	1250 POINTS

CATALOG



Model #	Description
WP439006	1500 POINTS

AD FLAG



Model #	Description
WP439011	1800 POINTS

BACKPACK



Model #	Description
WP281028	2850 POINTS

POLO SHIRT



Model #	Description
WP439014	2400 POINTS

POLO SHIRT



Model #	Description
WP439013	2450 POINTS

3-IN-1 JACKET



Model #	Description
WP439012	6000 POINTS

BEACH UMBRELLA



Model #	Description
WP439007	4200 POINTS

DISPLAY RACK (1000x2200x450MM)



Model #	Description
WP289008	12000 POINTS

DISPLAY RACK (1480x1000x1200MM)



Model #	Description
WP439008	17500 POINTS

HEAVY-DUTY 1000MM DISPLAY SHELF



Model #	Description
WP289007	21000 POINTS



HAND TOOLS

HAND TOOLS

Screwdrivers
Striking Tools
Finishing Tools
Pliers
Knives & Multi-tools
Hex Keys
Nuts Drivers

LIMITED LIFETIME WARRANTY

WORKPRO warrants this product for its useful life against deficiencies in material and workmanship.

Warranty does not cover products that are improperly used, abused, excessive wear, damaged from accident, altered or repaired, nor does it cover consumable goods such as knife blades, bits, glue sticks, etc. Excludes all incidental or consequential damages.

MECHANICS TOOLS

Ratchets & Sockets
Wrenches & Wrench Sets
Mechanics Tool Sets
Torque Wrenches

FULL LIFETIME WARRANTY

If any WORKPRO mechanics tool ever fails for any reason, WORKPRO will replace it.

Warranty does not cover products that are improperly used, abused, excessive wear, damaged from accident, altered or repaired. Excludes all incidental or consequential damages.

*For CR-V mechanics tools only.

ELECTRIC MEASURING TOOLS

Torpedo Digital Levels
Standard Digital Levels
Lasers
Lasers Distance Measurers

2 YEAR LIMITED WARRANTY

For TWO YEARS from the date of sale, WORKPRO warrants this product is warranted against defects in material or workmanship.

Warranty does not cover products that are improperly used, abused, altered, or repaired. Excludes all incidental or consequential damages.

*This warranty does not apply to cordless battery packs or chargers (These products have separate and different warranties).

TAPE MEASURES

General Tape Measures

LIMITED LIFETIME WARRANTY

WORKPRO warrants this product for its useful life against deficiencies in material and workmanship.

Warranty does not cover products that are improperly used, abused, excessive wear, damaged from accident, altered or repaired. Excludes all incidental or consequential damages. Please refer to the below replacement policy as a guide to determine if a tape measure is defective and should be replaced.

Tape Measure Replacement Policy

CONDITIONS COVERED BY WARRANTY
A tape measure showing defects in material or workmanship like those examples below will be replaced free of charge.

- Missing hook rivets
- Broken spring, blade will not retract
- Detective component: broken slide lock/ lock won't hold
- Missing coating

CONDITIONS NOT COVERED BY WARRANTY

Tape measures indicating excessive wear or showing damage from an accident or misuse will not be replaced free of charge.

- Torn or damaged blade
- Foreign material on blade or in case
- Rusty blade or hook
- Worn out beyond expected life
- Mistreated or abused (cracked or open case)

TOOL STORAGE

Metal Tool Box
Portable Plastic Storage
Polyester Storage Tool Bag
Workbench

2 YEAR LIMITED WARRANTY

For TWO YEARS from the date of sale, WORKPRO warrants this product is warranted against defects in material or workmanship.

Warranty does not cover products that are improperly used, abused, altered, repaired, or improper storage. Excludes all incidental or consequential damages.

*This warranty does not apply to accessories such as zippers, buttons, and other similar items.

MANUAL GARDEN TOOLS

Hand Cultivator
Hand Fork
Weeder
Trowel
Garden Tool Sets

2 YEAR LIMITED WARRANTY

For TWO YEARS from the date of sale, WORKPRO warrants this product is warranted against defects in material or workmanship.

Warranty does not cover products that are improperly used, abused, excessive wear, damaged from accident, altered or repaired. Excludes all incidental or consequential damages.

THIS WARRANTY WILL NOT APPLY IF

- The product has not been used or maintained in accordance with the instructions.
- Defects resulting from normal wear and tear.
- Partially or completely dismantled tools.
- Improper installation, failure to follow recommended installation and operational instructions, neglect, willful damage, misuse or vandalism, accidental damage, alteration or tampering.
- Damage incurred in shipping or handling.
- Damage caused by disasters such as fire, flood, wind, earthquake or lightning.
- The tool has been operated on a supply voltage other than specified on the tool.
- The product fault, failure or damage is caused as a result of any repairs to the product which are made or attempted by a service provider other than WORKPRO, or authorized distributors/ dealers.
- The product has been subjected to incorrect electrical supply or inconsistent electrical supply, or used with inappropriate accessories.
- The product's serial number has been altered or removed from the product; or products which are not identified with the Seller's product label and lot number or serial number.
- Wear and tear parts and accessories, including but not limited to maintenance kits, carbon brushes, bearings, spindles, drill bits, auxiliary handles, suitcases, sand plates, dust bags, dust exhaust pipes, felt washers, pins and springs, piston/driver assemblies, piston stops, driver blades, rubber o-rings, seals, isolators, air filters, and driver belts, slings, gears, saw chains, nozzles, wheels, cutting lines, drill chucks, saw blades, milling cutters, abrasive belts, grinding wheels and other related items and other accessories; electronic components: fuses, rechargeable batteries and chargers, power cords, plugs, switches, and electronic circuit boards; accessories and accessories included with the machine.

WHAT TO DO IF THE WARRANTY IS VALID

Step 1 Visit www.workprotool.com to see product warranty information.

Step 2 If the product is within the **warranty period***, you can return it to the store where you bought it. You can also mail the product to the store, but you should bear the cost and risk of transport to and from the dealer. **Proof of purchase** required.
*The Warranty period starts from the date you purchase the Product and ceases upon the expiration of the period. Your original purchase invoice (sales receipt or order confirmation e-mail), showing the date of purchase and product description, is your proof of the date of purchase. The warranty period of the product will not be extended or updated through our warranty service.

Step3 **Pack the unit** in a well-padded sturdy carton if you do not have the original packaging.

Step4 The retailer will evaluate the product and provide **free repair services** to address a defect in the materials or workmanship of a product. In the case of failure to repair, the product will be replaced for free.

More questions? Email service@workprotool.com

www.workprotool.com



WORKPRO[®]

NOT JUST PROFESSIONAL

Designed and Qualified by GreatStar Industrial USA, LLC
Produced by Hangzhou GreatStar Industrial Co.,Ltd., the largest tool manufacturer and supplier in Asia.



Official Website

@workprotoolsglobal

service@workprotool.com sales@workprotool.com

+86 13456852654

+86 571 81601328

No.35 Jiuhan Road, Shangcheng District, Hangzhou, China

9836-A Northcross Center Court, Huntersville, North Carolina 28078, Mecklenburg, USA