

# SWISS+TECH

- + MULTI-TOOLS
- + KNIVES
- + LIGHTING
- + SHEARS
- + DRINKWARE



POWER YOUR ADVENTURE





# SWISS+TECH

## WHO WE ARE

Founded in his Ohio-based garage in 1994, Swiss+Tech is the creation of mechanical engineer Larry K. Legg. While working at a mechanical accessory parts company, Legg saw a need for multi-purpose tools that were smaller and more compact than what was currently on the market. Leveraging his engineering background, he set out to make his own micro sized multi-tools. The end result? A collection of the most compact and useful multi-tools ever developed. Infused with American innovation and Swiss craftsmanship, Legg appropriately named his new line of micro sized multi-tools Swiss+Tech.

With their unique design and myriad of uses, Swiss+Tech tools became an overnight success and earned a number of patents. As time went by, Swiss+Tech became a renowned international brand.

Today, Swiss+Tech is proud to be a part of GreatStar Tools U.S.A., a subsidiary of the GreatStar Group of companies. Swiss+Tech and GreatStar are joining forces to take the Swiss+Tech brand and product offering to an entirely new level. So no matter what your next project or outdoor adventure has in store, Swiss+Tech tools, lights and knives will be there when you need them - to ensure things get done right.



# CONTENTS

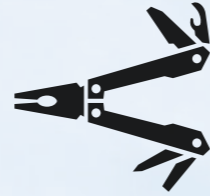

Multi-Tools P21-P36



Lighting P37-P66

**SWISS+TECH**



Knives P1-P20



Shears P67-P68



Drinkware P69-P76

GOOD BRANDING IS  
ABOUT FEELINGS.  
CREATE FEELINGS.

The Swisstech strategy can seem very simple, create feelings around it's products. Feelings of desire, feelings of intrigue, and elegance. Feelings drive brand loyatly.



POWER YOUR ADVENTURE



## Bi-Metal Carbon Fiber Ball Bearing Folding Knife

ST012006

High performance, Good looking, Super light

Blade Size: 3.5"  
Blade Material: Bi-Metal Carbide Blade  
Blade Finish: Grey Titanium  
Blade Type: Drop Point & Straight  
Handle: Carbon Fiber  
Belt Clip: Y  
Lanyard: Y



**Mini** FOLDING KNIFE

ST014008

Blade Size: 1.25"  
Blade Material: 420HC (4CR13)  
Blade Finish: Black Oxide  
Blade Type: Tanto & Straight

Handle: Stainless Steel  
Belt Clip: N  
Lanyard: Y



FOLDING KNIFE

ST014007

Blade Size: 1.5"  
Blade Material: 420HC (4CR13)  
Blade Finish: Black Oxide  
Blade Type: Spey Point

Handle: Stainless Steel  
Belt Clip: N  
Lanyard: Y



**Mini** FOLDING KNIFE

ST014011

Blade Size: 1.75"  
Blade Material: 420HC (4CR13)  
Blade Finish: Satin Polish  
Blade Type: Drop Point & Straight

Handle: Aluminum  
Belt Clip: Y  
Lanyard: Y



**Money Clip** FOLDING KNIFE



ST014010

Blade Size: 2.5"  
Blade Material: 420HC (4CR13)  
Blade Finish: Stone Wash  
Blade Type: Tanto & Straight

Handle: Stainless Steel  
Belt Clip: Y  
Lanyard: Y

**4"** FOLDING KNIFE



ST014021

Blade Size: 4"  
Blade Material: 420HC (4CR13)  
Blade Finish: Black Oxide  
Blade Type: Drop Point & Serrated

Handle: Nylon  
Belt Clip: Y  
Lanyard: Y

**3.5"** FOLDING KNIFE



ST014012

Blade Size: 3.5"  
Blade Material: 420HC (4CR13)  
Blade Finish: Black Oxide  
Blade Type: Drop Point & Straight

Handle: Nylon  
Belt Clip: Y  
Lanyard: Y

**Ball Bearing** FOLDING KNIFE



ST014020

Blade Size: 3.5"  
Blade Material: 420HC (4CR13)  
Blade Finish: Grey Titanium

Handle: Nylon  
Belt Clip: Y  
Lanyard: N

**4"** FOLDING KNIFE



ST014016

Blade Size: 4"  
Blade Material: 420HC (4CR13)  
Blade Finish: Satin Polish  
Blade Type: Drop Point & Serrated

Handle: Nylon  
Belt Clip: Y  
Lanyard: Y

**3.5"** FOLDING KNIFE



ST014013

Blade Size: 3.5"  
Blade Material: 420HC (4CR13)  
Blade Finish: Satin Polish  
Blade Type: Drop Point & Straight

Handle: Nylon  
Belt Clip: Y  
Lanyard: Y



# YOU CANNOT BE EVERYTHING

3.5" Speed Opening Folding Knife

ST014015

Red ring here for decoration as family code  
Durable nylon material with fiber glass  
Built-in quick opening mechanism

## SPEED OPENING UTILITY KNIFE

ST015002

Blade Material: SK5  
Handle: Nylon  
Belt Clip: Y  
Lanyard: Y



## SPEED OPENING FOLDING KNIFE

ST014014

Blade Size: 3.5"  
Blade Material: 420HC (4CR13)  
Blade Finish: Satin Polish  
Blade Type: Drop Point

Handle: Nylon  
Belt Clip: Y  
Lanyard: N

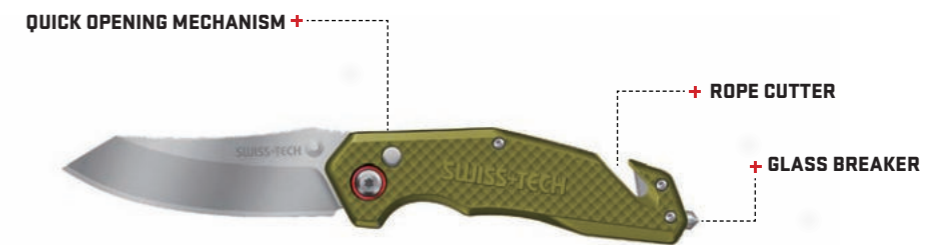

## FOLDING KNIFE

ST014018

Blade Size: 3.5"  
Blade Material: 420HC (4CR13)  
Blade Finish: Satin Polish  
Blade Type: Tanto

Handle: Aluminum  
Belt Clip: Y  
Lanyard: N





# WALK ON THE WAY YOU CHOOSE





# BI-METAL



STAY SHARP  
LONGER  
**5X**

Laser deposited tungsten carbide along the blade's edge results in an ultra-hard and super-sharp finish, providing longer first-cut sharpness

## G10 BI-METAL FOLDING KNIFE



### ST012001

|                                        |              |
|----------------------------------------|--------------|
| Blade Size: 3.5"                       | Handle: G10  |
| Blade Material: Bi-Metal Carbide Blade | Belt Clip: Y |
| Blade Finish: Satin Polish             | Lanyard: Y   |
| Blade Type: Drop Point & Straight      |              |

## G10 BI-METAL FOLDING KNIFE



### ST012002

|                                        |              |
|----------------------------------------|--------------|
| Blade Size: 3.5"                       | Handle: G10  |
| Blade Material: Bi-Metal Carbide Blade | Belt Clip: Y |
| Blade Finish: Black Titanium           | Lanyard: Y   |
| Blade Type: Drop Point & Straight      |              |

## SS&G10 BI-METAL FOLDING KNIFE



### ST012003

|                                        |                                     |
|----------------------------------------|-------------------------------------|
| Blade Size: 3.5"                       | Handle: Stainless Steel +G10 insert |
| Blade Material: Bi-Metal Carbide Blade | Belt Clip: Y                        |
| Blade Finish: Satin Polish             | Lanyard: N                          |
| Blade Type: Tanto & Straight           |                                     |

## SS&G10 BI-METAL FOLDING KNIFE



### ST012004

|                                        |                                     |
|----------------------------------------|-------------------------------------|
| Blade Size: 3.5"                       | Handle: Stainless Steel +G10 insert |
| Blade Material: Bi-Metal Carbide Blade | Belt Clip: Y                        |
| Blade Finish: Black Titanium           | Lanyard: N                          |
| Blade Type: Tanto & Straight           |                                     |

## Aluminum BI-METAL FOLDING KNIFE



### ST012005

|                                        |                  |
|----------------------------------------|------------------|
| Blade Size: 3.5"                       | Handle: Aluminum |
| Blade Material: Bi-Metal Carbide Blade | Belt Clip: Y     |
| Blade Finish: Black Oxide              | Lanyard: Y       |
| Blade Type: Drop Point & Straight      |                  |

## Carbon Fiber Ball Bearing BI-METAL FOLDING KNIFE



### ST012006

|                                        |                      |
|----------------------------------------|----------------------|
| Blade Size: 3.5"                       | Handle: Carbon Fiber |
| Blade Material: Bi-Metal Carbide Blade | Belt Clip: Y         |
| Blade Finish: Grey Titanium            | Lanyard: Y           |
| Blade Type: Drop Point & Straight      |                      |





**G10 FOLDING KNIFE**



**ST014001**

Blade Size: 3.5"  
Blade Material: Aus-8 (8Cr13Mov)  
Blade Finish: Satin Polish  
Blade Type: Drop Point & Straight

Handle: G10  
Belt Clip: Y  
Lanyard: Y

**G10 FOLDING KNIFE**



**ST014002**

Blade Size: 3.5"  
Blade Material: Aus-8 (8Cr13Mov)  
Blade Finish: Black Titanium  
Blade Type: Drop Point & Straight

Handle: G10  
Belt Clip: Y  
Lanyard: Y

**SS&G10 FOLDING KNIFE**



**ST014003**

Blade Size: 3.5"  
Blade Material: Aus-8 (8Cr13Mov)  
Blade Finish: Satin Polish  
Blade Type: Tanto & Straight

Handle: Stainless Steel +G10 insert  
Belt Clip: Y  
Lanyard: N

**SS&G10 FOLDING KNIFE**



**ST014004**

Blade Size: 3.5"  
Blade Material: Aus-8 (8Cr13Mov)  
Blade Finish: Black Titanium  
Blade Type: Tanto & Straight

Handle: Stainless Steel +G10 insert  
Belt Clip: Y  
Lanyard: N

**Aluminum Serrated FOLDING KNIFE**



**ST014005**

Blade Size: 3.5"  
Blade Material: Aus-8 (8Cr13Mov)  
Blade Finish: Satin Polish  
Blade Type: Drop Point & Serrated

Handle: Aluminum  
Belt Clip: Y  
Lanyard: Y

**Carbon Fiber Ball Bearing FOLDING KNIFE**



**ST014006**

Blade Size: 3.5"  
Blade Material: Aus-8 (8Cr13Mov)  
Blade Finish: Grey Titanium  
Blade Type: Drop Point & Straight

Handle: Carbon Fiber  
Belt Clip: Y  
Lanyard: Y





Your sport bar

# 10PC TARGETS

ST001039



## 3PC 4.4" FIXED BLADE KNIFE

ST001033

Blade Material: 420J2(3CR13)  
Blade Finish: Black Oxide  
Handle: Rope  
With Sheath



## 3.25" FIXED BLADE KNIFE

ST011005

Blade Material: 425M (5CR15Mov)  
Blade Finish: Black Oxide  
Handle: Rope  
With Nylon Sheath





**4" FIXED BLADE KNIFE**

ST011006

Blade Material: 425M(5Cr15Mov)  
Blade Finish: Satin Polish  
Handle: Wooden  
With Leather Sheath



**4.8" FIXED BLADE KNIFE**

ST011007

Blade Material: 425M(5Cr15Mov)  
Blade Finish: Satin Polish  
Handle: Wooden  
With Leather Sheath



**4.8" FIXED BLADE KNIFE**

ST011009

Blade Material: AUS-8 (8Cr13mov)  
Blade Finish: Black Oxide  
Handle: Nylon  
With Nylon Sheath



Fire Starter



**6.4" FIXED BLADE KNIFE**

ST011008

Blade Material: 425M(5Cr15Mov)  
Blade Finish: Satin Polish  
Handle: Wooden  
With Leather Sheath



**4.5" FIXED BLADE KNIFE**

ST011010

Blade Material: AUS-8 (8Cr13mov)  
Blade Finish: Black Oxide+Polish  
Handle: Aluminum  
With Nylon Sheath





# 11" MACHETE WITH AIR-TECH HANDLE

ST011403

Blade Material: AUS-8(8cr13mov)  
Blade Finish: Black Oxide  
Handle: TPE grip with AIR TECH CUSHION  
Sheath: Nylon



## 10" MACHETE

ST011404

Blade Material: 420J2(3CR13)  
Blade Finish: Black Oxide  
Handle: TPR  
Sheath: Oxford fabric



## 10" MACHETE

ST011405

Blade Material: 420J2(3CR13)  
Blade Finish: Satin Polish  
Handle: TPR  
Sheath: Oxford fabric



## 13" MACHETE

ST011406

Blade Material: 420J2(3CR13)  
Blade Finish: Black Oxide  
Handle: TPR  
Sheath: Oxford fabric





**13" MACHETE** ST011407

Blade Material: 420J2(3CR13)  
 Blade Finish: Satin Polish  
 Handle: TPR  
 Sheath: Oxford fabric



**13" MACHETE WITH AIR-TECH HANDLE** ST011410

Blade Material: 420J2(3CR13)  
 Blade Finish: Black Oxide+Polish  
 Handle: TPE grip with AIR TECH CUSHION  
 Sheath: Oxford fabric



**13" MACHETE** ST011408

Blade Material: 420J2(3CR13)  
 Blade Finish: Black Oxide  
 Handle: TPR  
 Sheath: Oxford fabric



**18" MACHETE WITH AIR-TECH HANDLE** ST011411

Blade Material: 420J2(3CR13)  
 Blade Finish: Black Oxide+Polish  
 Handle: TPE grip with AIR TECH CUSHION  
 Sheath: Oxford fabric



**13" MACHETE** ST011409

Blade Material: 420J2(3CR13)  
 Blade Finish: Satin Polish  
 Handle: TPR  
 Sheath: Oxford fabric



**Neck Knife** ST013900 **Neck Knife** ST013901

Blade Size: 2"  
 Blade Material: 420HC (4CR13)  
 Blade Finish: Black Oxide  
 Handle: Nylon+Fiber Glass  
 Sheath: Nylon

Blade Size: 2"  
 Blade Material: 420HC (4CR13)  
 Blade Finish: Satin Polish  
 Handle: Nylon+Fiber Glass  
 Sheath: Nylon





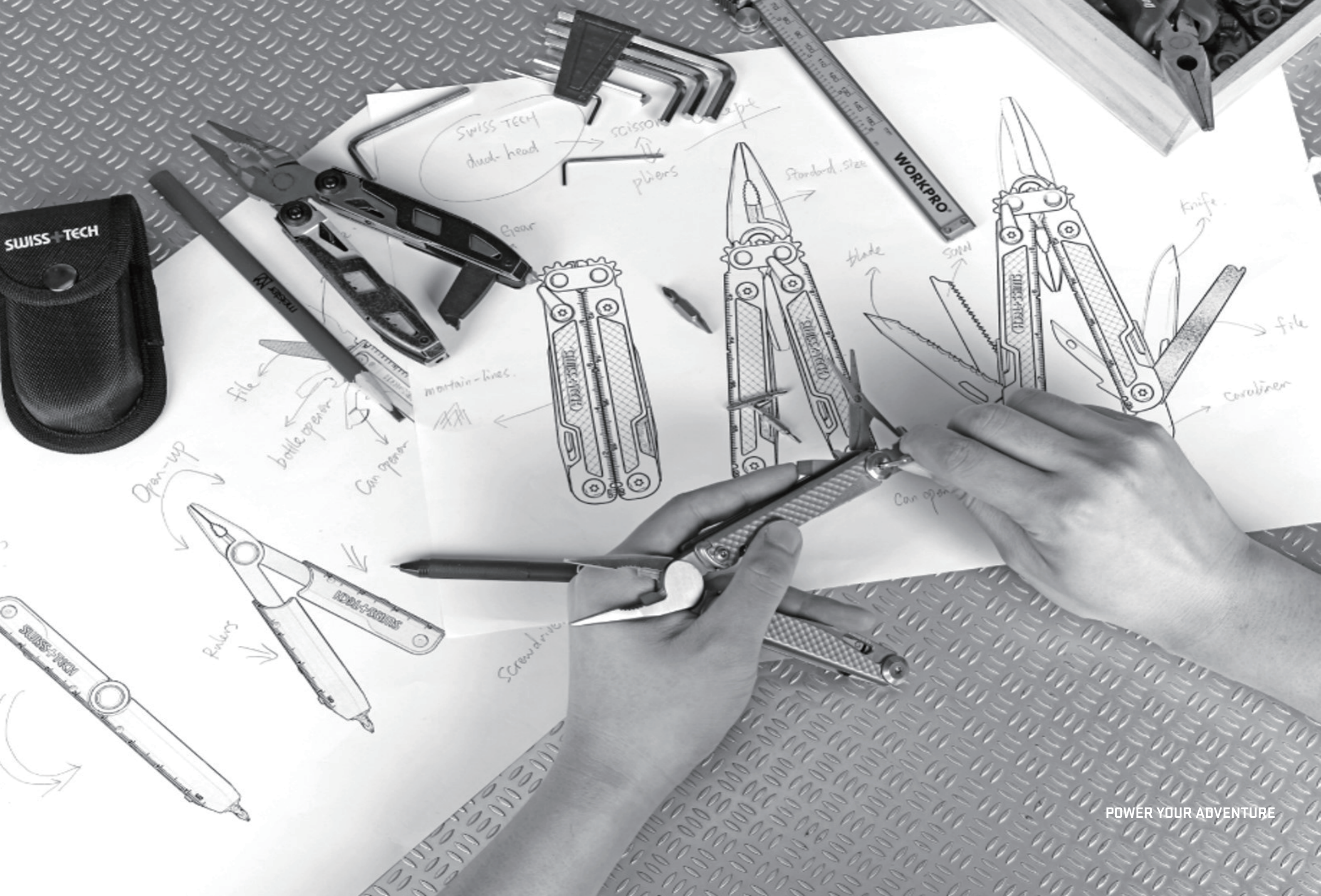

POWER YOUR ADVENTURE



**ST021007**  
**30-IN-1 Multi-Tool**

Dual Head

Blade Material: Aus-8 (8cr13mov)  
Blade Finish: Stone Wash  
Blade Type: Drop Point & Straight  
Handle: 3CR13  
File Finish: Diamond Coated  
Other Components Material: 3CR13  
Belt Clip: N  
Lanyard: N  
With Pouch



**17-IN-1 MULTI-TOOL**



**ST021006**

Blade Material: Aus-8 (8cr13mov)  
Blade Finish: Stone Wash  
Blade Type: Drop Point & Straight  
Handle: 3CR13  
File Finish: Diamond Coated  
Other Components Material: 3CR13  
Belt Clip: Y  
Lanyard: N

**13-IN-1 MULTI-TOOL**



**ST022001**

Blade Material: Aus-8(8cr13mov)  
Blade Finish: Stone Wash  
Blade Type: Drop Point & Straight  
Handle: 3CR13  
File Finish: Diamond Coated  
Other Components Material: 3CR13  
Belt Clip: N  
Lanyard: Y





ST85109

**4-IN-1** EMERGENCY HAMMER TOOL FOR AUTOMOBILE

- Designed for automobile using, compact size, orange warning color
- Easy to operate when windows or doors fail to use due to vehicle damage, fire or submersion

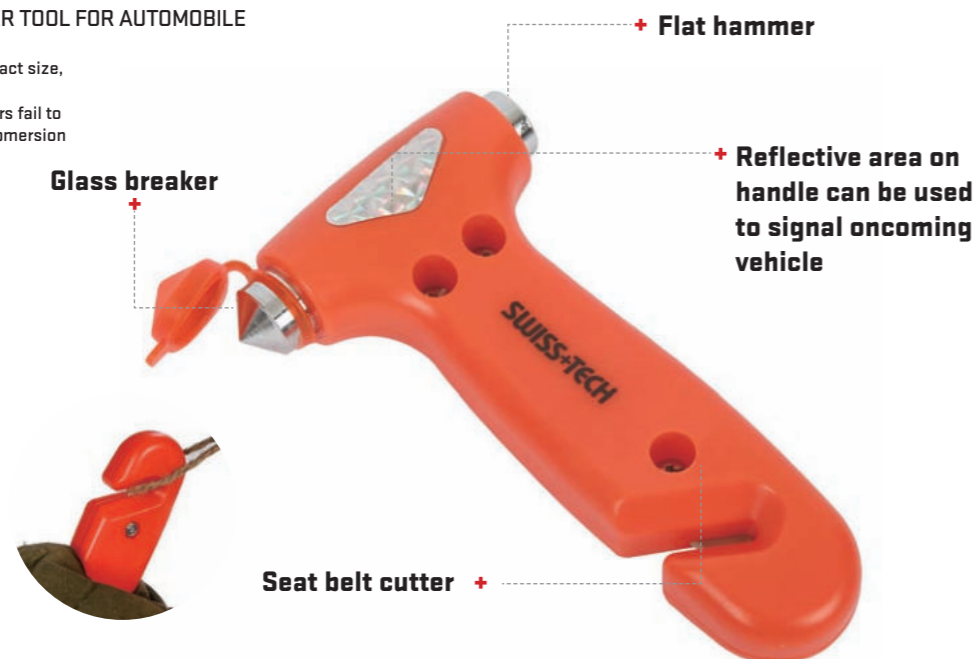

**3-IN-1** AUTOMOBILE EMERGENCY TOOL

- Super compact design for automobile using, Escape from vehicle easily under emergency
- Spring-loaded, instant reset



ST81010

**5-IN-1** AUTOMOBILE EMERGENCY TOOL

- Super compact design for automobile using, Escape from vehicle easily under emergency
- Spring-loaded, instant reset



ST81005

**7-IN-1** AUTOMOBILE EMERGENCY TOOL

- Super compact design for automobile using, Escape from vehicle easily under emergency
- Spring-loaded, instant reset
- Utility car tire tool setting

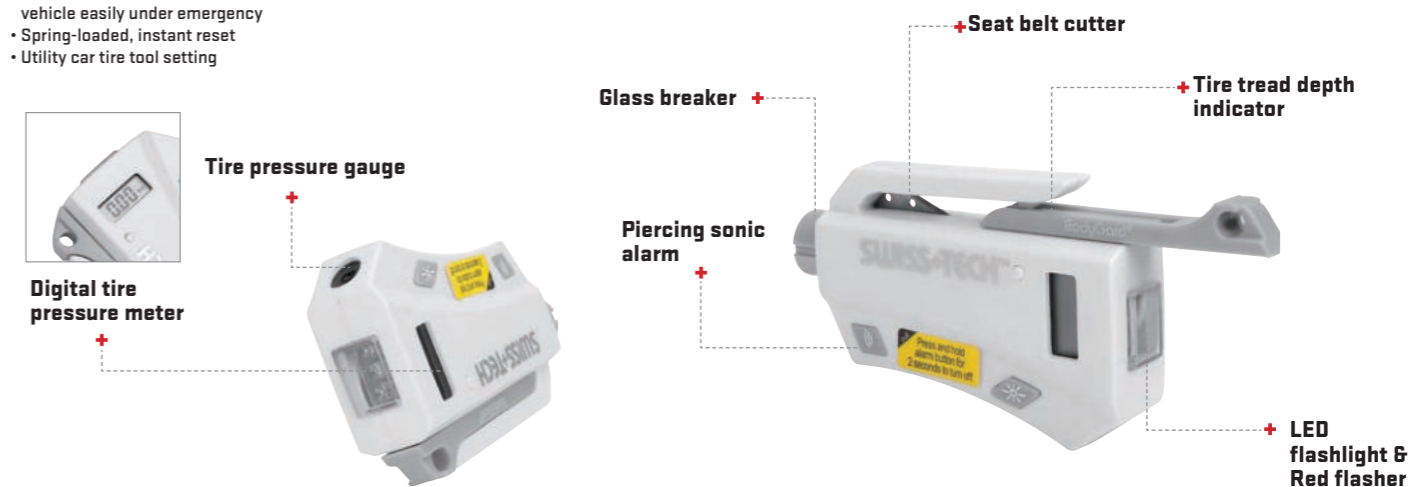

ST81562



**6-IN-1** UTILITY KEY

ST66676

- Solid Stainless Steel
- 6-IN-1 Function, Compact, versatile and convenient design, easy to carry as key chain.

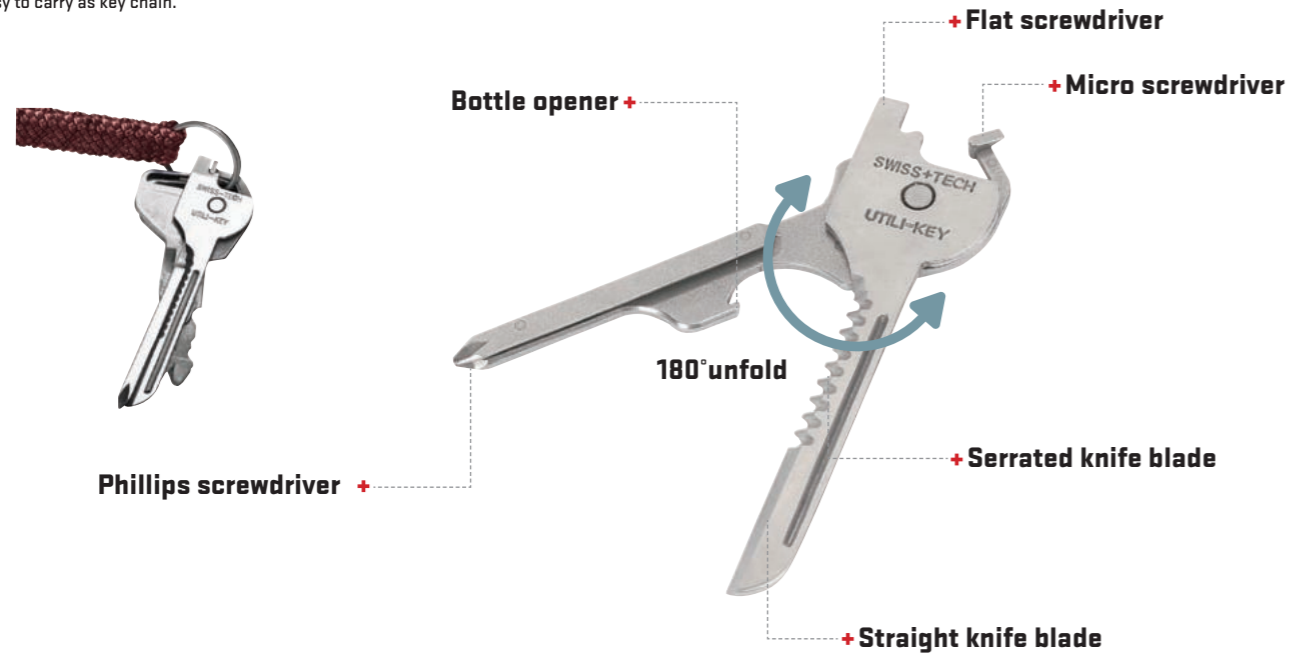

**9-IN-1** KEY RING MICRO EX MULTI-TOOL

ST50016

- Solid stainless steel, pocket size, super compact key ring design
- Patented quick-release mechanism, change tools in seconds. Securely locks onto key ring

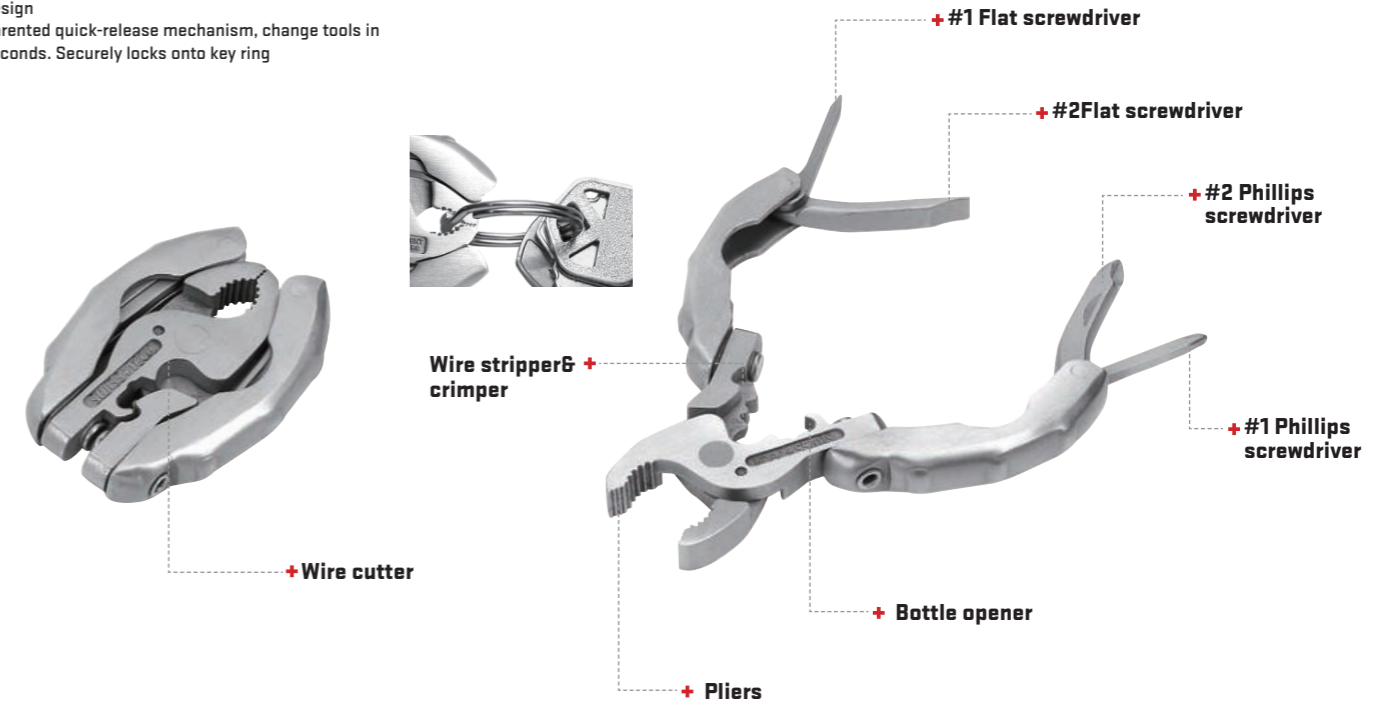

**6-IN-1** KEY RING MICRO TOOL

ST50022

- Solid stainless steel micro Pliers. Rule marking on the swivel handle design
- Easy to work as key chain when folded

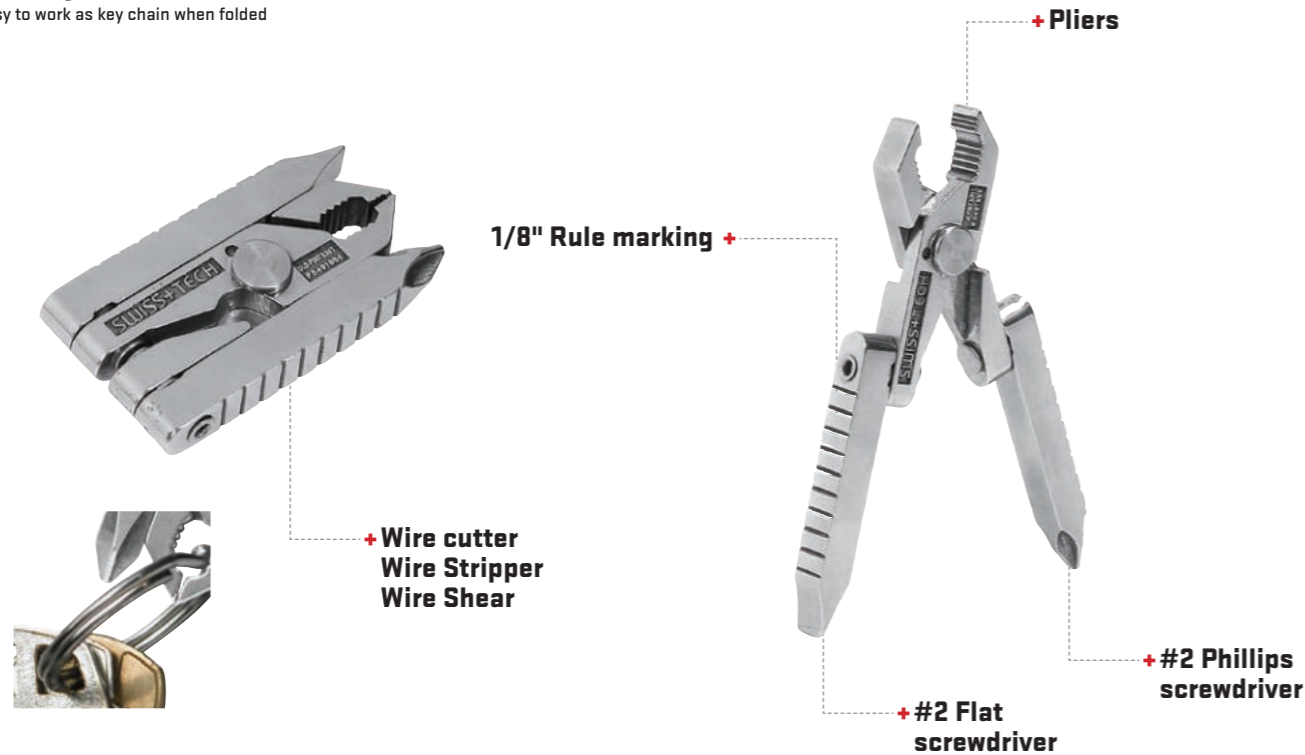

**19-IN-1** KEY RING MICRO MAX MULTI TOOL

ST53100

- Solid stainless steel micro max plier tool. Up to 19 functions included
- Compact size, easy to carry or use as key chain.
- 2 Wrenches, 6 Screwdrivers, Pliers, File, 3 Wire tools, Micro hand drill, Bottle Opener, 2 Rulers & extensions





**22-IN-1** MINI EXTREME MULTI TOOL

ST53130

- Solid stainless steel heavy-duty micro pliers. Rule marking on the swivel handle design.
- Compact size, easy to carry in pocket or bag. 22 functions in total
- 2 Wrenches, 6 Screwdrivers, Pliers, File, 3 Wire tools, Micro hand drill, Bottle Opener, 2 Rulers & extensions



**15-IN-1** CREDIT CARD MULTI-TOOL

ST33309

- A stainless steel credit card size 15-IN-1 Multi-Function pocket tool
- Ultra slim design, easy to carry in pocket and wallet

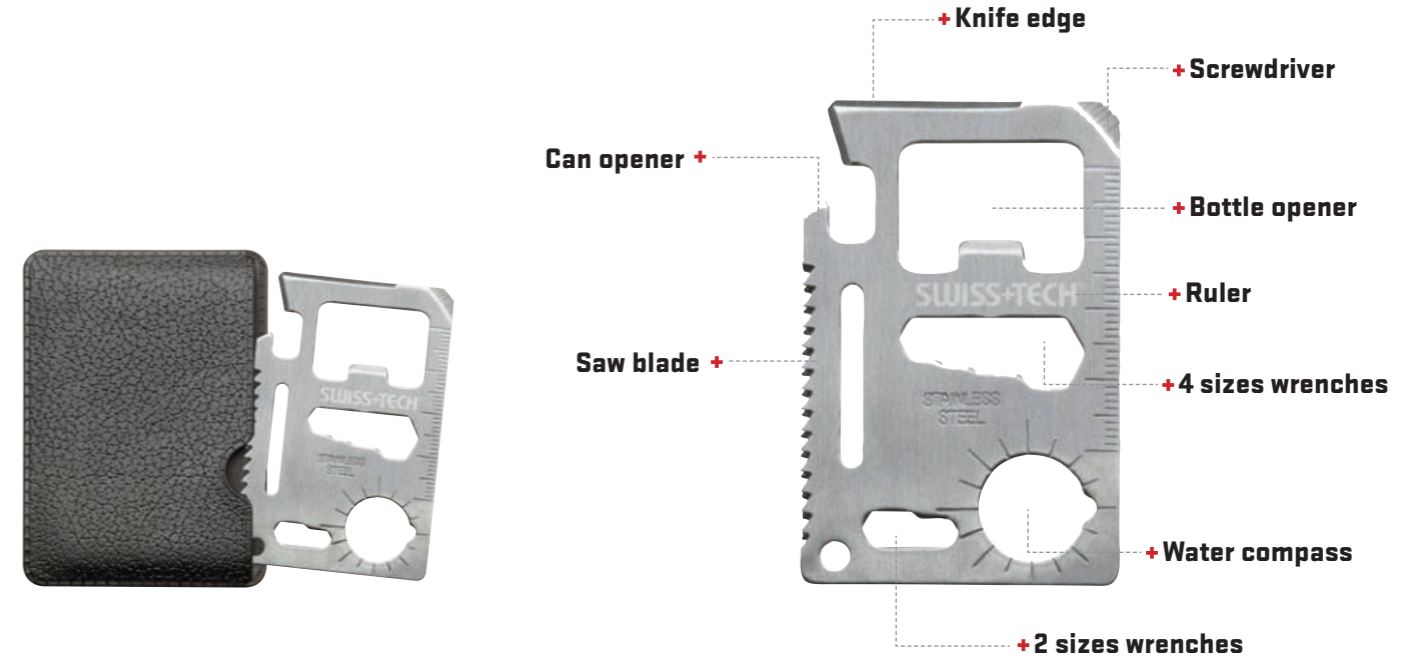

**14-IN-1** FLAT WRENCH MULTI-TOOL

ST67129

- This is a solid stainless steel micro slim key wrench, quite convenient to use as a key chain.
- Compact size.

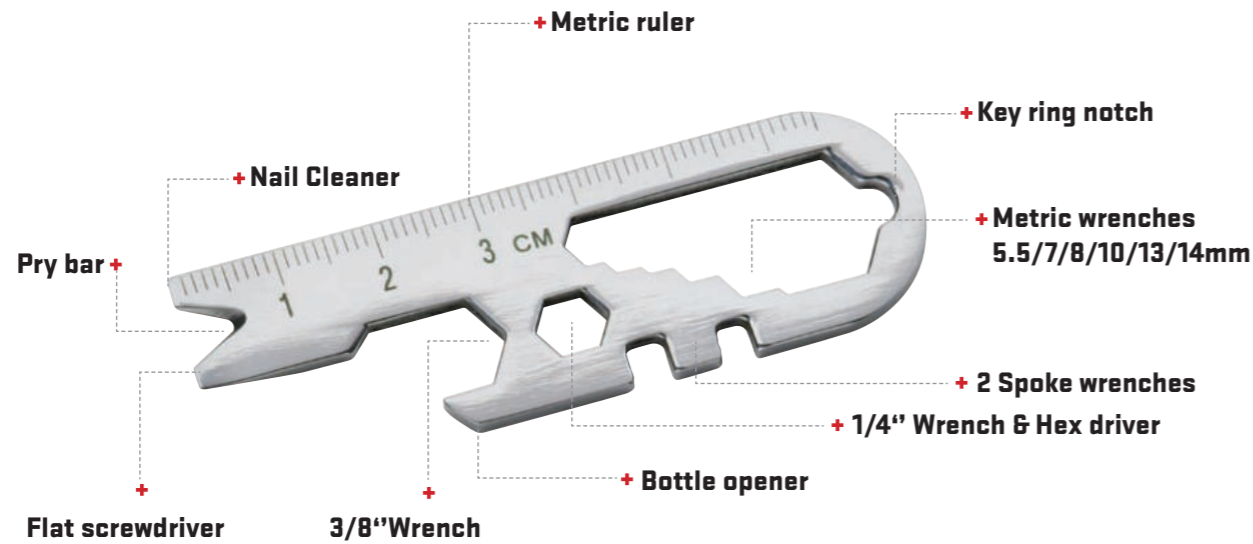

**17-IN-1** CREDIT CARD MULTI-TOOL

ST33329

- A solid stainless steel credit card size 17-IN-1 Multi-Function pocket tool
- Shows SOS and HELP in Morse code
- Ultra slim design, easy to carry in pocket and bag

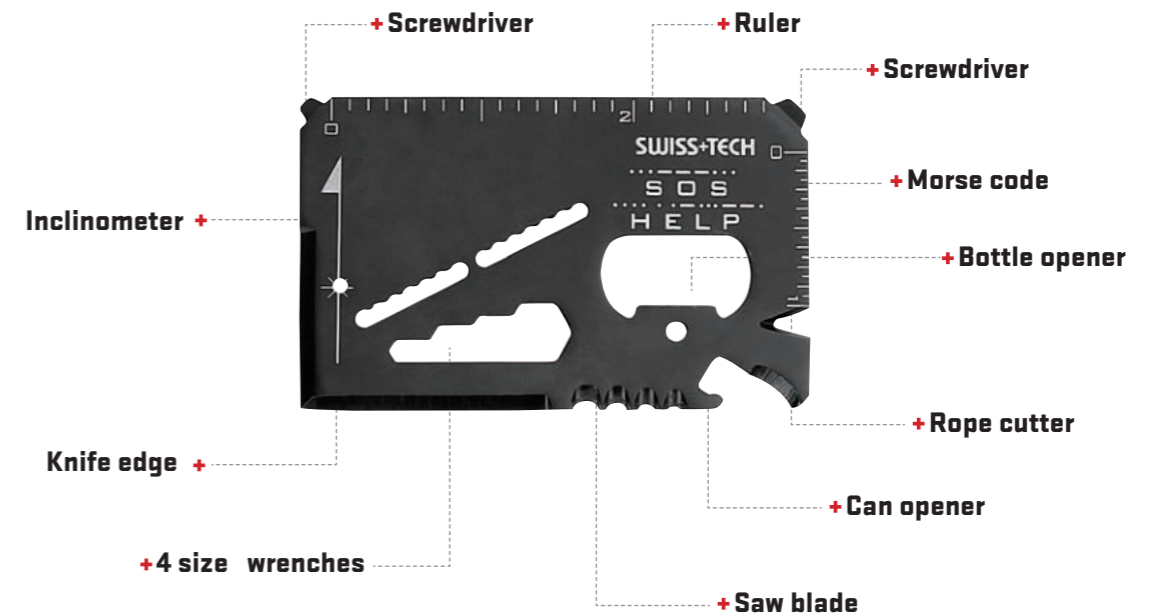



**11-IN-1** MULTI TOOL

ST029010

• A Stainless Steel EDC card tool, 3Cr13

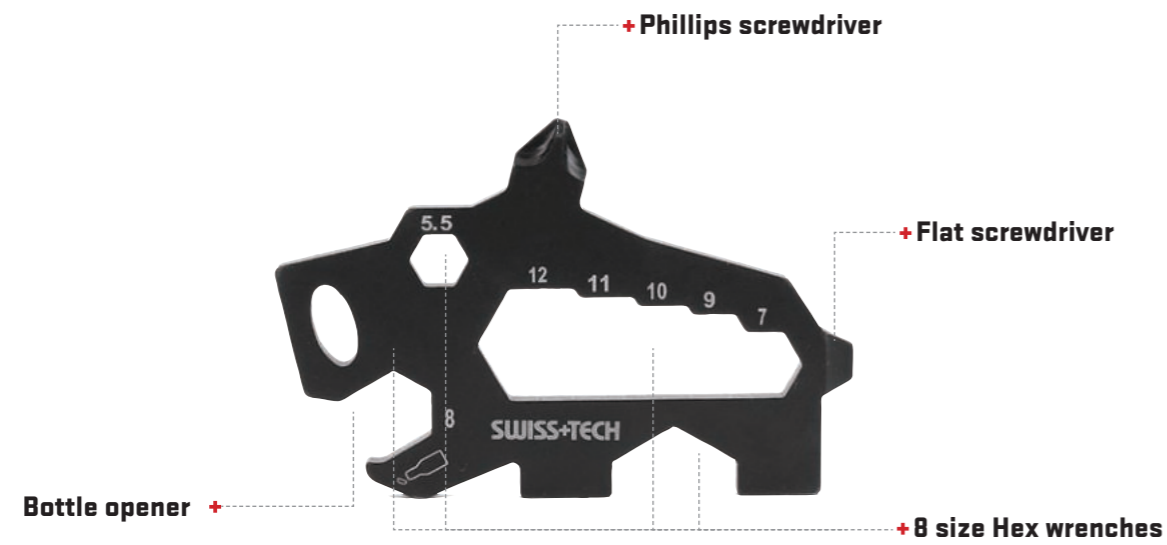

**8-IN-1** MULTI TOOL

ST029012

• A Stainless Steel EDC card tool, 3Cr13

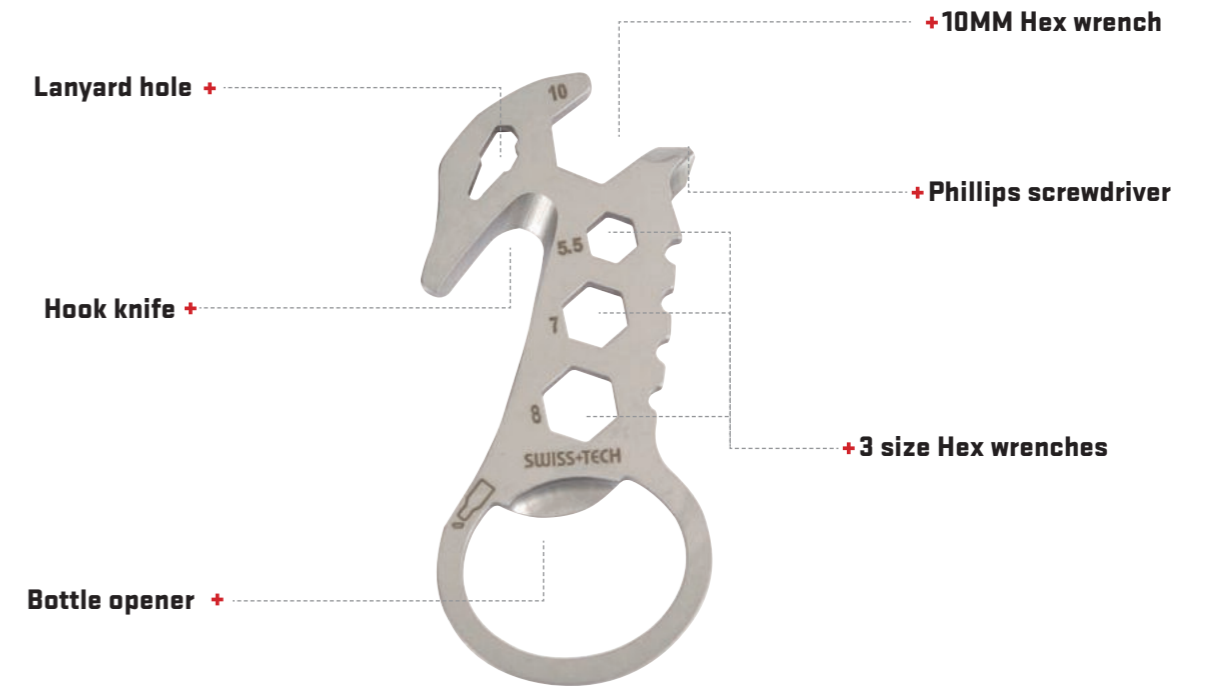

**10-IN-1** MULTI-TOOL

ST029011

• A Stainless Steel EDC card tool, 3Cr13

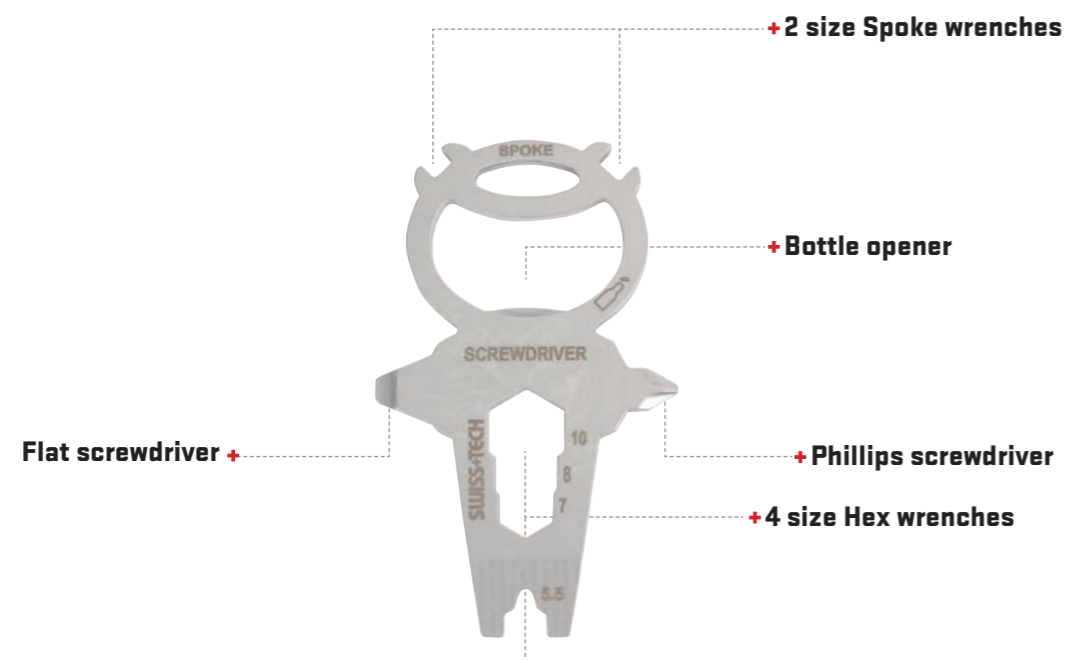



# 4-IN-1 MULTI-FUNCTION PEN LIGHT

High performance, Good looking

Blade Material: 425M(5cr13mov)  
Blade Finish: Bead blasting  
Blade Type: Drop Point & Straight  
Handle: Aluminum  
Other Components Material: 3CR13  
Belt Clip: Y  
Lanyard: N

POWER YOUR ADVENTURE

FLAT  
SCREWDRIVER

+ BOTTLE OPENER



KNIFE +



+ POCKET CLIP



+ LED FLASHLIGHT

ST021008





# SwissTech ST021011

## 26-IN-1 Multi Tool

High performance, Good looking

Blade Material: 425M (5CR15Mov)

Blade Finish: Bead Blasting

Blade Type: Drop Point & Straight

Handle: Aluminum

Bits: S2

Other Components Material: 3CR13

Belt Clip: Y

Lanyard: N

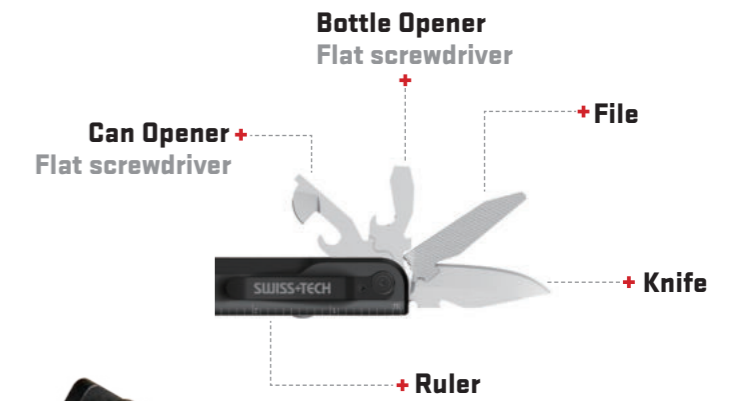

### Long nose pliers +

Bolt gripper +

Soft wire cutter +

Hard wire cutter +





**SWISS+TECH**

**LIGHT UP YOUR WORLD**

**POWER  
YOUR  
ADVENTURE**



EVERYDAY

## Concise

**SWISS+TECH** Handheld Flashlight Everyday Concise provides superb durability and handle feeling with its exclusive appearance design. The family provides sizes from 1AAA to 3D for various selection. Duracell batteries included for whole series. Smart choice for everyday use. Families provides various models from 1AAA to 3D for selection. Duracell batteries included for whole series. Smart choice for indoor & outdoor using.





# ALUMINUM FLASHLIGHT



| SKU#     | Description                    | Mode                | Lumen (High/Low) | Run Time (High/Low) | Beam Distance (High/Low) | IP Prograss | Drop Proof |
|----------|--------------------------------|---------------------|------------------|---------------------|--------------------------|-------------|------------|
| ST031013 | 3D aluminum flashlight         | High/Low/ECO/Strobe | 700/200/15       | 15/35/500           | 300/90                   | IPX4        | 1          |
| ST031012 | 2D aluminum flashlight         | High/Low/Strobe     | 350/100          | 15/21               | 300/150                  | IPX4        | 1          |
| ST031011 | 3C aluminum flashlight         | High/Low/ECO/Strobe | 550/160/15       | 15/25/250           | 280/150                  | IPX4        | 1          |
| ST031010 | 6AA aluminum flashlight        | High/Low/ECO/Strobe | 700/200/15       | 3.5/12/80           | 300/100                  | IPX4        | 1          |
| ST031009 | 4AA aluminum flashlight        | High/Low/Strobe     | 500/250          | 3/11                | 250/180                  | IPX4        | 1          |
| ST031008 | 2AA focus aluminum flashlight  | High/Low/Strobe     | 200/50           | 1.5/8               | 100/50                   | /           | 1          |
| ST031007 | 2AA aluminum flashlight        | High/Low/Strobe     | 250/80           | 2.5/8               | 100/50                   | /           | 1          |
| ST031006 | 1AA aluminum flashlight        | High/Low/Strobe     | 100/30           | 2/3                 | 60/30                    | /           | 1          |
| ST031005 | 4AAA aluminum flashlight       | High/Low/Strobe     | 420/120          | 3/9                 | 220/80                   | IPX4        | 1          |
| ST031004 | 3AAA focus aluminum flashlight | High/Low/Strobe     | 300/90           | 3/9                 | 180/80                   | /           | 1          |
| ST031003 | 3AAA aluminum flashlight       | High/Low/Strobe     | 280/80           | 3.5/9               | 150/60                   | IPX4        | 1          |
| ST031002 | 2AAA aluminum flashlight       | on-off              | 90               | 3                   | 50                       | /           | 1          |
| ST031001 | 1AAA aluminum flashlight       | on-off              | 60               | 1.5                 | 30                       | /           | 1          |



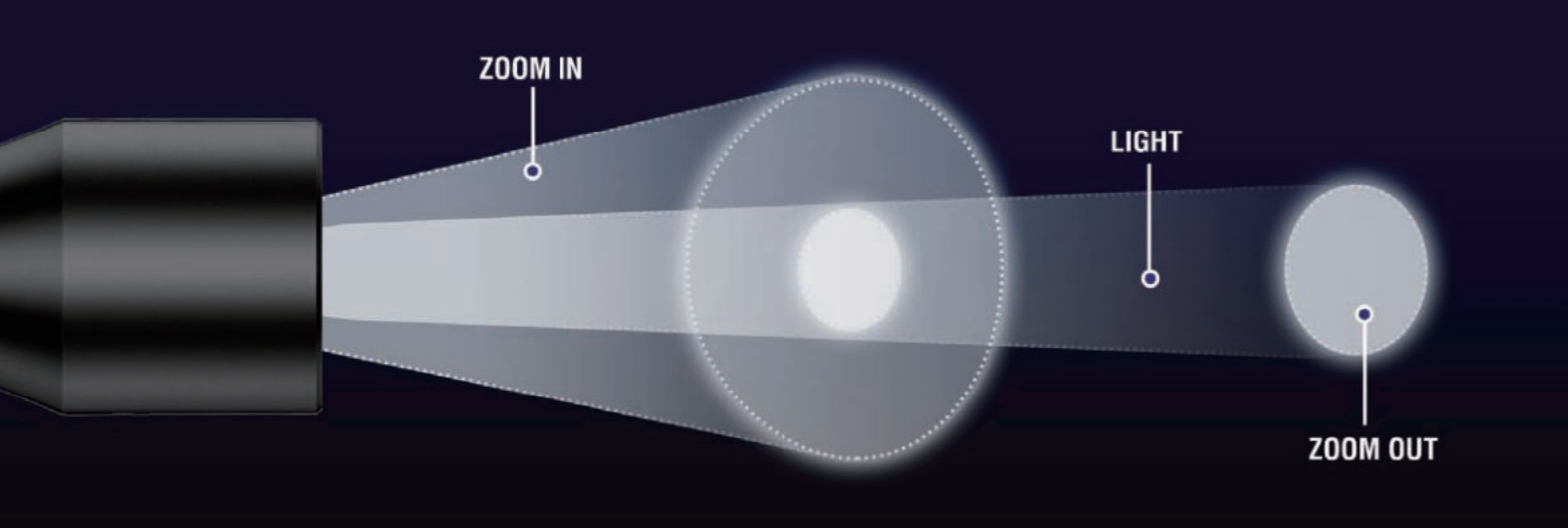

Focus for Long Distance Light



Dual Beam to Get Long Distance and Wide Range Light



**VISUALLY INDESTRUCTIBLE**

# Indestructible

**SWISS+TECH** Handheld Flashlight Indestructible provides superb durability and handle feeling with its exclusive appearance design. The family provides sizes from 1AAA to 3D for various selection. IPX7 and 9M drop-resistant. Duracell batteries included for whole series. 3 Dual-Light source model included.



1AAA    2AAA    2AA    2AA DUAL LIGHT    3AAA    3AAA DUAL LIGHT    4AAA    4AA    4AA DUAL LIGHT    6AA    3C    2D    3D



# ALUMINUM FLASHLIGHT



| SKU#     | Description                                    | Mode                      | Lumen (High/Low) | Run Time (High/Low) | Beam Distance (High/Low) | IP Prograss | Drop Proof |
|----------|------------------------------------------------|---------------------------|------------------|---------------------|--------------------------|-------------|------------|
| ST031310 | 3D drop proof aluminum flashlight              | High/Low/Moonlight/Strobe | 750/210          | 15/35/500           | 350/100                  | IPX7        | 9          |
| ST031309 | 2D drop proof aluminum flashlight              | High/Low/Strobe           | 400/120          | 8/21                | 280/90                   | IPX7        | 9          |
| ST031308 | 3C drop proof aluminum flashlight              | High/Low/Strobe           | 650/200          | 12/29               | 350/110                  | IPX7        | 9          |
| ST031307 | 6AA drop proof aluminum flashlight             | High/Low/Moonlight/Strobe | 750/210          | 3.5/12/80           | 300/100                  | IPX7        | 9          |
| ST031306 | 4AA drop proof aluminum flashlight             | High/Low/Moonlight/Strobe | 550/180          | 3/11/50             | 200/70                   | IPX7        | 9          |
| ST031305 | 2AA dual light drop proof aluminum flashlight  | High/Low/Flood/Strobe     | 300/90           | 2.5/10              | 80/30                    | IPX7        | 9          |
| ST031304 | 2AA drop proof aluminum flashlight             | High/Low/Strobe           | 250/80           | 2.5/10              | 100/35                   | IPX7        | 9          |
| ST031303 | 4AAA drop proof aluminum flashlight            | High/Low/Strobe           | 450/140          | 3/11                | 150/80                   | IPX7        | 9          |
| ST031302 | 3AAA dual light drop proof aluminum flashlight | High/Low/Flood/Strobe     | 350/110          | 3/11                | 100/40                   | IPX7        | 9          |
| ST031301 | 3AAA drop proof aluminum flashlight            | High/Low/Strobe           | 300/90           | 3/11                | 150/50                   | IPX7        | 9          |
| ST031300 | 2AAA drop proof aluminum flashlight            | High/Low/Strobe           | 90/25            | 2/9                 | 35/15                    | IPX7        | 9          |
| ST031311 | 1AAA drop proof aluminum flashlight            | High/Low/Strobe           | 75/20            | 1.5/8               | 30/10                    | IPX7        | 9          |
| ST031312 | 4AA dual light drop proof aluminum flashlight  | High/Low/Flood/Strobe     | 600/190          | 3/11                | 120/50                   | IPX7        | 9          |



## USB RECHARGEABLE

**SWISS+TECH** Handheld Flashlight Eco-Friendly **Rechargeable** provides superb durability and handle feeling with its exclusive appearance design. The family provides 6 models all with USB recharge port, 3AAA model interchangeable with 18650 Li-ion.



## ALUMINUM FLASHLIGHT



| SKU#     | Description                                    | Mode            | Lumen (High/Low) | Run Time (High/Low) | Beam Distance (High/Low) | Water Proof | Drop Proof |
|----------|------------------------------------------------|-----------------|------------------|---------------------|--------------------------|-------------|------------|
| ST031600 | 1x10440 rechargeable flashlight                | High/Low/Strobe | 100/30           | 2/5                 | 30/10                    | IPX4        | 1M         |
| ST031601 | 3AAA&18650 rechargeable flashlight             | High/Low/Strobe | 400/120          | 3/10                | 180/80                   | IPX4        | 1M         |
| ST031602 | 3AAA&18650 Focus rechargeable flashlight       | High/Low/Strobe | 450/150          | 3/10                | 100/30                   | /           | 1M         |
| ST031608 | 2x18650 rechargeable flashlight                | High/Low/Strobe | 1000/300         | 4/12                | 350/100                  | IPX4        | 1M         |
| ST031604 | 3AAA&18650 rechargeable drop proof flashlight  | High/Low/Strobe | 450/150          | 3/10                | 150/80                   | IPX4        | 3M         |
| ST031609 | 2x18650 rechargeable drop proof flashlight     | High/Low/Strobe | 1000/300         | 4/12                | 350/100                  | IPX4        | 3M         |
| ST031603 | 4AA&1x26650 rechargeable flashlight            | High/Low/Strobe | 1000/300         | 4/12                | 350/100                  | IPX4        | 1M         |
| ST031605 | 4AA&1x26650 rechargeable drop proof flashlight | High/Low/Strobe | 1000/300         | 4/12                | 350/100                  | IPX4        | 3M         |



# TACTICAL FLASHLIGHT

**SWISS+TECH** Handheld Flashlight Tactical series owns Glass Reinforced Nylon Covers a Metal Core, which provides superb durability and handle feeling. High performance Dual-Light source system is carried for all models.



3AAA DUAL LIGHT

4AAA DUAL LIGHT



| SKU#     | Description              | Mode                                                                    | Lumen (High/Low) | Run Time (High/Low) | Beam Distance (High/Low) | IP Progress | Drop Proof |
|----------|--------------------------|-------------------------------------------------------------------------|------------------|---------------------|--------------------------|-------------|------------|
| ST031806 | 4AA tactical flashlight  | 4 Mode:SPOT+Flood,SPOT,Flood, StrobeMode:SPOT+Flood, SPOT,Flood, Strobe | 600              | 3                   | 150                      | IPX8(2M+1H) | 3M         |
| ST031809 | 3AAA tactical flashlight | 4 Mode:SPOT+Flood,SPOT,Flood, Strobe                                    | 400              | 3                   | 75                       | IPX8(2M+1H) | 3M         |



**LED**  
LANTERN



# DUAL PURPOSE CAMPING LANTERN

ST033001

IPX4 ✓ 1M

Mode: High/Low  
Lumen (High/Low): 150/50

Run Time: 5/12H  
Beam Distance: 5/3M



ST031016

# MULTI FUNCTION FINDER

3AAA UV FLASHLIGHT

UV perfect for detecting banknotes, pet urine, scorpion and spots that are not visible by the naked eye



SCORPIONS



COUNTERFEIT



PET URINE



FLUORESCER



UV  
LIGHT



**LED**  
FLASHLIGHT



# PARTICULAR

## 2AA-4AA PLASTIC FLASHLIGHT



ST031800/ ST031801

Mode: High/Low/Strobe  
Lumen ( High/Low ): 200

**IPX7** ✓ 1M

Run Time ( High/Low ): 5  
Beam Distance ( High/Low ): 75

## Key chain Light



ST039007

Lumen ( High/Low ): 45  
Run Time ( High/Low ): 1.5h

**IPX4** ✓ 1M

Beam Distance ( High/Low ): 25m

## 2PC Glasses Flashlight

ST039006

Lumen ( High/Low ): 45  
Run Time ( High/Low ): 1.5h

**IPX4** ✓ 1M

Beam Distance ( High/Low ): 25m



## 3AAA GLOW-IN-THE-DARK flashlight

**SWISS+TECH** Handheld Flashlight Special models provides various certain models which can be used in particular environment. All in compact and concise design.



| SKU#     | Description                              | Mode            | Lumen (High/Low) | Run Time (High/Low) | Beam Distance (High/Low) | IP Progress | Drop Proof |
|----------|------------------------------------------|-----------------|------------------|---------------------|--------------------------|-------------|------------|
| ST031324 | 3AAA Glow-in-the-dark flashlight(Pink)   | High/Low/Strobe | 300/100          | 3/10                | 150/80                   | IPX4        | 1M         |
| ST031325 | 3AAA Glow-in-the-dark flashlight(Green)  | High/Low/Strobe | 300/100          | 3/10                | 150/80                   | IPX4        | 1M         |
| ST031326 | 3AAA Glow-in-the-dark flashlight(Orange) | High/Low/Strobe | 300/100          | 3/10                | 150/80                   | IPX4        | 1M         |





# AUTO DIMMING

## 4AA AUTO-DIMMING ALUMINUM FLASHLIGHT



ST031014

Mode: High/Low/Strobe  
Lumen ( High/Low ): 450/150

**IPX4** ✓ **1M**

Run Time ( High/Low ): 3/12  
Beam Distance ( High/Low ): 200/100

## 6AA AUTO-DIMMING ALUMINUM FLASHLIGHT



ST031015

Mode: High/Low/Strobe  
Lumen ( High/Low ): 700/200

**IPX4** ✓ **1M**

Run Time ( High/Low ): 3.5/15  
Beam Distance ( High/Low ): 300/150

## AUTO DIMMING MODE

To Select Auto-Dimming Mode, Press and Hold ON/OFF Button until Green LED Light Comes on

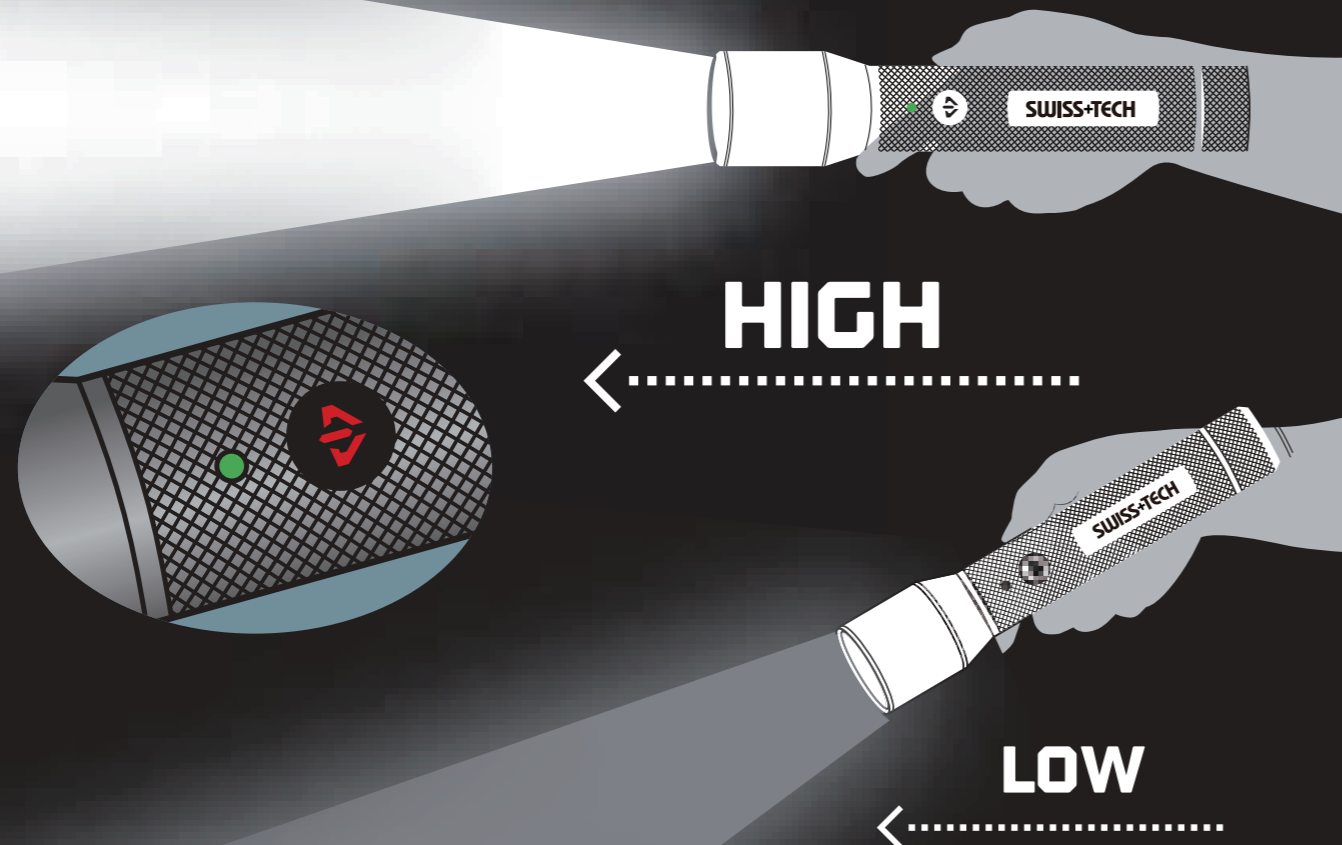





ST091002  
Multi tool

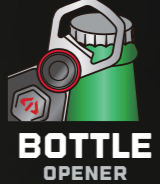

- SS body and ABS parts
- Compact size, easy to carry or use as key chain
- Bottle Opener
- 5LM LED light for emergency
- Finger spinner, relieve the pressure





# PIVOTING FLASHLIGHT

90 DEGREE ROTATE & MAGNETIC TAIL CAP & BELT CLIP & These three feature work together providing hand free operation.  
DUAL BEAM-Both flood and spot beam. No need to focus, you can have both long distance and big area.

**ST031017**

**4AAA** FLASHLIGHT

Mode: Spot+Flood/Spot/Flood

Lumen: 450

Run Time: 2

Beam Distance: 100





A man with a beard and a headlamp, wearing a dark jacket and carrying a large blue backpack, standing in a snowy mountain landscape. The scene is filled with falling snow, and the background shows rugged, snow-covered peaks under a bright sky. The man is looking off to the side with a focused expression.

**LIGHT PROVIDES US WITH  
WARMTH AND LIGHT**



**3AAA HEADLAMP**



**ST032002** **IPX4** **1M**  
 Mode: High/Low/Strobe  
 Lumen: 250  
 Run Time : 3  
 Beam Distance: 80

**4AAA FOCUS HEADLAMP**



**ST032001** **1M**  
 Mode: High/Low/Strobe  
 Lumen ( High/Low ): 400  
 Run Time ( High/Low ): 2  
 Beam Distance ( High/Low ): 100

**Rechargeable headlamp**



**ST032004** **IPX4** **1M**  
 Mode: High/Low/Strobe  
 Lumen ( High/Low ): 300  
 Run Time ( High/Low ): 3  
 Beam Distance ( High/Low ): 80M

**Rechargeable headlamp**



**ST032007** **IPX4** **1M**  
 Mode: Spot High/Spot Low/Flood/Spot + Flood/Strobe  
 Lumen : 320  
 Run Time : 3  
 Beam Distance : 80

**Glow stick**



**ST039004** **IPX4** **1M**

|     |       |      |                   |
|-----|-------|------|-------------------|
| 1   | 2     | 3    | 4                 |
|     |       |      |                   |
| RED | GREEN | BLUE | AUTO COLOR CHANGE |

**Glow stick**



**ST039008** **IPX4** **1M**

|     |       |      |                   |
|-----|-------|------|-------------------|
| 1   | 2     | 3    | 4                 |
|     |       |      |                   |
| RED | GREEN | BLUE | AUTO COLOR CHANGE |

# REAR LI-ION RECHARGEABLE HEADLAMP

**Lumen: 550LM**  
**Mode: High/Medium/Low, Red Strobe/Red SOS/Green**  
**Drop Proof: 2M**  
**Water Proof: IPX4**  
 Reflective Strip On Back for Safety Warning.

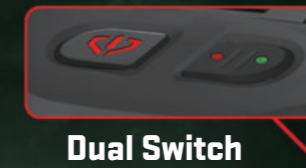

**ST032003**





# DROP FORGED SHEARS

3X high cutting strength



## Drop forged shears

3X high cutting strength

Multi-function use

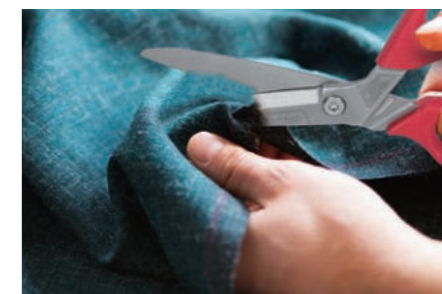

| SKU#     | Description          | size | Material |
|----------|----------------------|------|----------|
| ST016005 | SwissTech 7" Shears  | 7"   | 60CRV    |
| ST016006 | SwissTech 8" Shears  | 8"   | 60CRV    |
| ST016009 | SwissTech 9" Shears  | 9"   | 60CRV    |
| ST016008 | SwissTech 10" Shears | 10"  | 60CRV    |
| ST016010 | SwissTech 9" Shears  | 9"   | 3CR13    |
| ST016011 | SwissTech 9" Shears  | 9"   | 3CR13    |



**DRINKWARE  
KEEPS COOL, STAYS HOT**







## Pint Cup

Easy To Clean  
18/8 Stainless Steel  
Suitable For Gift-giving  
Easy to spot with different designs

| Des                  | Material              | Surface treatment |
|----------------------|-----------------------|-------------------|
| 4pack 140Z/413ml cup | Stainless Steel #18/8 | Powder coating    |
| 4pack 160Z/473ml cup | Stainless Steel #18/8 | Powder coating    |



## Pint Cup

Easy To Clean  
18/8 Stainless Steel  
Suitable For Gift-giving  
Easy to spot with different designs

| Des                                      | Material              | Surface treatment |
|------------------------------------------|-----------------------|-------------------|
| 2pack 200Z/591ml cup                     | Stainless Steel #18/8 | Powder coating    |
| 2pack <b>double layer</b> 160Z/473ml cup | Stainless Steel #18/8 | Powder coating    |

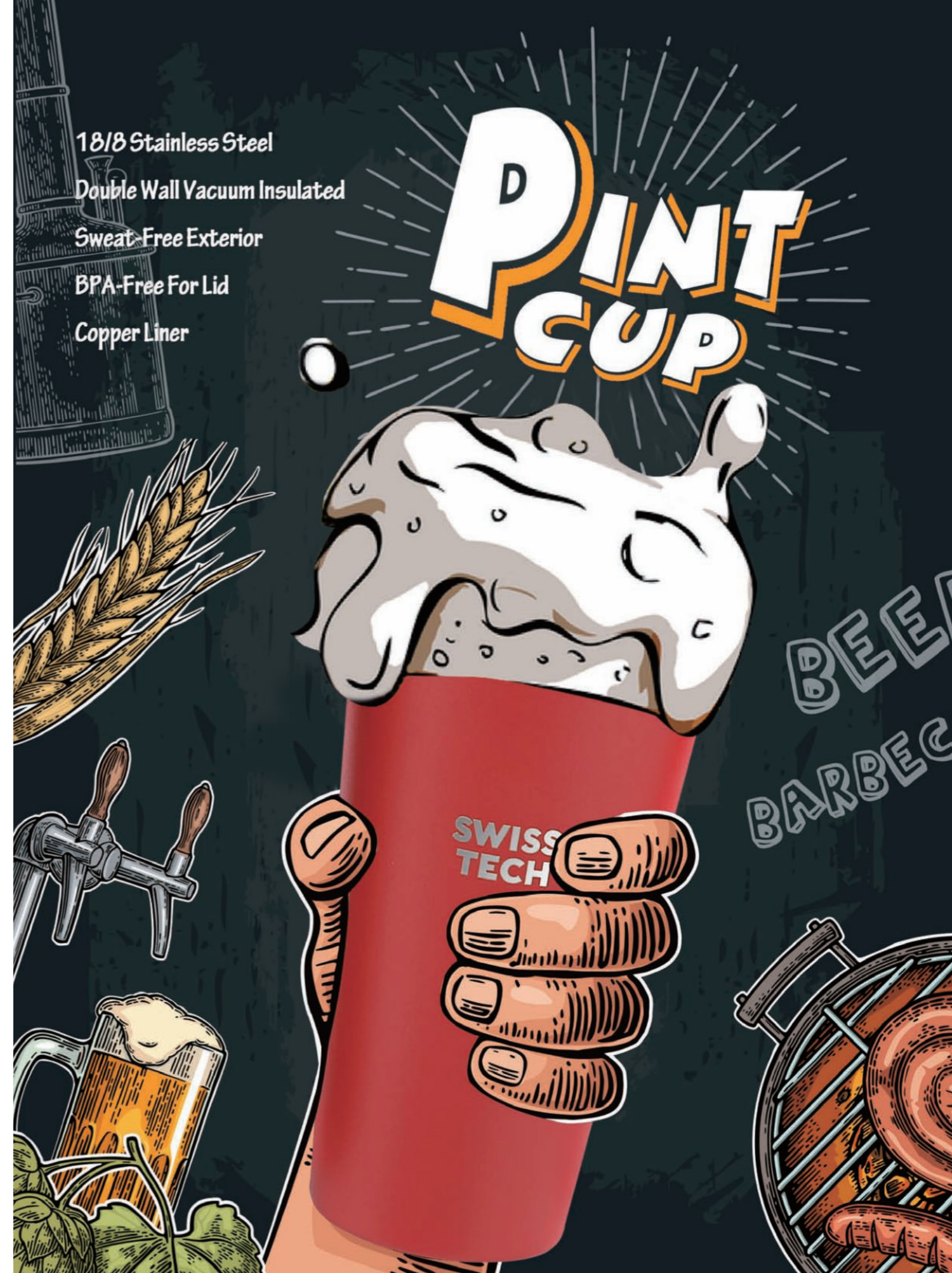





## Bottle

18/8 Stainless Steel  
 Double Wall Vacuum Insulated  
 Sweat-Free Exterior  
 BPA-Free For Lid  
 Copper Liner



| Des                | Material              | Surface treatment |
|--------------------|-----------------------|-------------------|
| 18OZ/532ml Bottle  | Stainless Steel #18/8 | Powder coating    |
| 48OZ/1419ml Bottle | Stainless Steel #18/8 | Powder coating    |
| 64OZ/1892ml Bottle | Stainless Steel #18/8 | Powder coating    |

## Gift Set

18/8 Stainless Steel  
 Double Wall Vacuum Insulated  
 Sweat-Free Exterior  
 BPA-Free For Lid  
 Copper Liner



| Des                                        | Material              | Surface treatment |
|--------------------------------------------|-----------------------|-------------------|
| 2pc tumbler set(20oz/591ml&10oz/295ml)     | Stainless Steel #18/8 | Powder coating    |
| 2pc tumbler&mug set(20oz/591ml&14oz/413ml) | Stainless Steel #18/8 | Powder coating    |

## Mug

18/8 Stainless Steel  
 Double Wall Vacuum Insulated  
 Sweat-Free Exterior  
 BPA-Free For Lid  
 Copper Liner



| Des            | Material              | Surface treatment |
|----------------|-----------------------|-------------------|
| 14OZ/413ml Mug | Stainless Steel #18/8 | Powder coating    |





## Tumbler

18/8 Stainless Steel  
 Double Wall Vacuum Insulated  
 Sweat-Free Exterior  
 BPA-Free For Lid  
 Copper Liner



| Des                 | Material              | Surface treatment |
|---------------------|-----------------------|-------------------|
| 30OZ/887ml Tumbler  | Stainless Steel #18/8 | Powder coating    |
| 20OZ/591ml Tumbler  | Stainless Steel #18/8 | Powder coating    |
| 10OZ/295ml Tumbler  | Stainless Steel #18/8 | Powder coating    |
| 24OZ/709ml Tumbler  | Stainless Steel #18/8 | Powder coating    |
| 34OZ/1005ml Tumbler | Stainless Steel #18/8 | Powder coating    |





**Copyright © 2022 GreatStar Tools USA, Inc. All rights reserved.  
WWW.SWISSTECHTOOLS.COM**